

USER MANUAL **BLK – GLD STICKER SERIES**

Black and gold stickers for measuring
convective and radiative heat flux separately



Cautionary statements

Cautionary statements are subdivided into four categories: danger, warning, caution and notice according to the severity of the risk.

 DANGER
Failure to comply with a danger statement will lead to death or serious physical injuries.

 WARNING
Failure to comply with a warning statement may lead to risk of death or serious physical injuries.

 CAUTION
Failure to comply with a caution statement may lead to risk of minor or moderate physical injuries.

NOTICE
Failure to comply with a notice may lead to damage to equipment or may compromise reliable operation of the instrument.

Contents

Cautionary statements	2
Contents	3
List of symbols	4
Introduction	5
1 Ordering and checking at delivery	9
1.1 Ordering BLK – GLD stickers	9
1.2 Included items	11
2 Instrument principle and theory	12
2.1 Introduction	12
2.2 Normal use: moderate-accuracy and comparative measurements	14
3 Advanced use: high-accuracy measurements	15
3.1 Introduction	15
3.2 Spectral properties of BLK and GLD stickers	15
3.3 BLK and GLD sensors on the same heat sink	17
3.4 BLK and GLD sensors at different temperatures	21
3.5 Surface temperature correction at high flux levels	22
3.6 Optional correction for sensor temperature dependence	24
3.7 Working with high colour temperature sources; the Sun, Xenon lamps	25
4 Examples of BLK and GLD in use	26
4.1 Outgoing radiation heat flux on metallic / reflective surfaces	26
4.2 Sources covering part of the sensor field of view; the view factor	27
4.3 Heat flux measurement to characterise ovens, thermal profiling	29
5 Specifications of BLK – GLD sticker series	33
5.1 Specifications of BLK – GLD stickers	33
5.2 Dimensions of BLK – GLD stickers	37
6 Installation of BLK – GLD sticker series	39
6.1 Application procedure	39
6.2 Site selection and sensor installation	41
7 Maintenance and trouble shooting	44
7.1 Recommended maintenance and quality assurance	44
7.2 Trouble shooting	46
7.3 Calibration and on-site checks	47
8 Appendices	48
8.1 Reflection versus wavelength and source temperature	48
8.2 EU declaration of conformity	51

List of symbols

Quantities

Heat flux
 Voltage
 Sensitivity
 Temperature
 Temperature dependence of sensitivity
 Thermal resistance per unit area
 Heat transfer coefficient by convection
 Area
 Reflection factor
 Absorbance
 Emissivity
 Stefan-Boltzmann constant: 5.67×10^{-8}
 Optical view factor
 Angle of incidence
 Solid angle

Symbol	Unit
Φ	W/m ²
U	V
S	V/(W/m ²)
T	°C or K
TD	%/K
R _{thermal,A}	K/(W/m ²)
C _{tr}	(W/m ²)/K
A	m ²
r	-
a	-
ε	-
σ	W/m ² ·K ⁴
f	-
θ	°
SA	sr

Subscripts

Property of sensor
 Property of heat sink
 Property of a radiative source
 Measured radiative heat flux
 Measured convective heat flux
 Sensor with black sticker
 Sensor with gold sticker
 Property of ambient air
 Property of ambient environment
 Total
 Emitted radiative flux
 Incoming radiative flux at the sensor position
 Absorbed radiative flux
 Reflected radiative flux

sensor
 sink
 source
 radiative
 convective
 BLK
 GLD
 air
 ambient
 total
 emitted
 incoming
 absorbed
 reflected

Abbreviations

Ultraviolet	UV
Visible light	VIS
Near-infrared	NIR
Far-infrared	FIR

Introduction

Heat flux measurement is a powerful tool to gain insights into processes involving the transport of thermal energy. Heat is transported to an object by convection and radiation. Studying thermal processes, the cause of temperature changes or heat transport, you may wish to separate radiative and convective heat flux. This is now possible with the BLK – GLD sticker series, designed to be used with a wide range of our market-leading heat flux sensors. The BLK black absorbing stickers absorb all radiation and are sensitive to both radiative and convective heat flux, while the GLD gold reflective stickers reflect all radiation and are sensitive to convective heat flux only. Applying BLK and GLD stickers, on two separate heat flux sensors, makes it possible to calculate the contributions of radiative and convective heat flux:

$$\Phi_{\text{radiative}} + \Phi_{\text{convective}} = \Phi_{\text{total}} = \Phi_{\text{BLK}}$$

$$\Phi_{\text{convective}} = \Phi_{\text{GLD}}$$

$$\Phi_{\text{radiative}} = \Phi_{\text{BLK}} - \Phi_{\text{GLD}}$$

BLK – GLD stickers have unique features and benefits:

- makes it possible to perform convective and radiative heat flux measurements
- available as accessory for the five models of the FHF05 series, including the FHF05SC models and HFP01 heat flux sensors
- designed to be applied by the user (also available pre-applied at the factory)



Figure 0.1 From left to right: model FHF05-50X50 heat flux sensor, FHF05-50X50 with BLK-50X50 sticker, and FHF05-50X50 with GLD-50X50 sticker. BLK – GLD stickers are also available for other dimensions of the FHF05 series and HFP01 heat flux sensors. The BLK black absorbing stickers will absorb all radiation and are sensitive to both radiative and convective heat flux, while the GLD gold reflective stickers reflect all radiation and are sensitive to convective heat flux only.

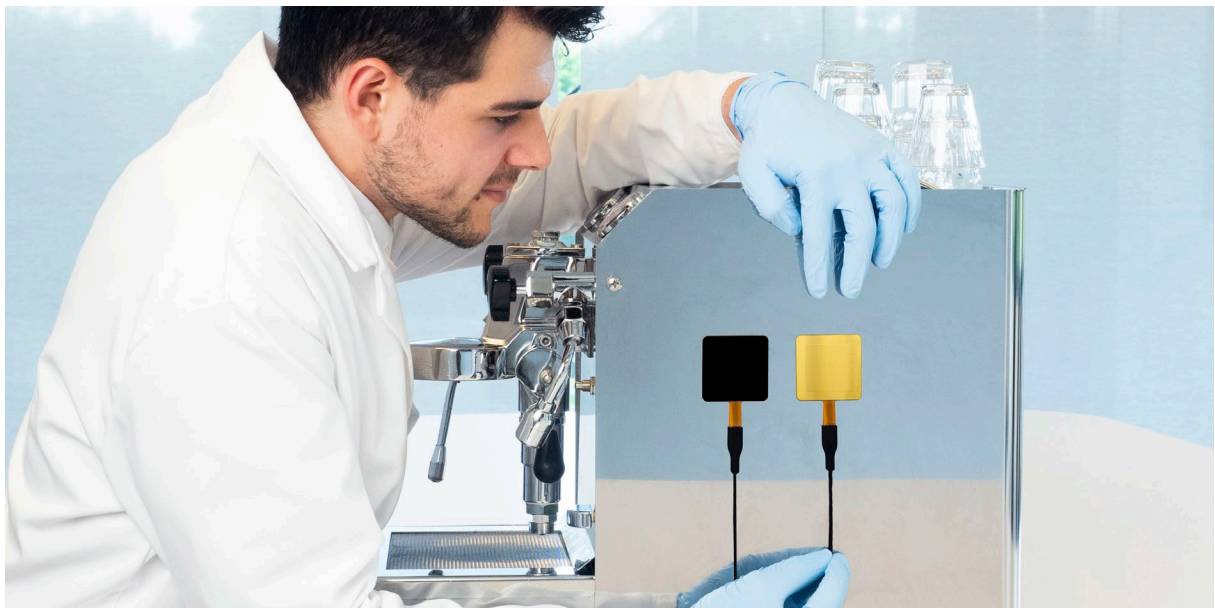

Figure 0.2 Working with BLK – GLD stickers: measuring the radiative and convective heat fluxes on an espresso machine.

BLK – GLD stickers are easy to use:

They are designed to be applied by the user, but can optionally also be pre-applied at the factory. Applying a sticker to a heat flux sensor does not change the sensitivity of the sensor, so no additional calibration is required. Using the reliable measurement technology behind our heat flux sensors, separating convective and radiative heat flux has never been easier.



Figure 0.3 *BLK – GLD sticker series is a range of accessories for use with Hukseflux heat flux sensors of the FHF05 series and HFP01. The stickers are matching sizes and are designed to be applied by the user to the sensor.*

The use of BLK and GLD stickers is restricted: in particular, if there is a notable amount of solar radiation, the GLD sticker will absorb a significant part of it.

NOTICE

Treat BLK and GLD stickers with care. Avoid abrasive action. Clean gently with a soft cloth and, if needed, with demi-water. The gold layer of the GLD sticker is extremely thin and may easily be rubbed off.

NOTICE

The GLD sticker will not perfectly reflect radiation from sources with blackbody temperatures higher than 4000 K. Solar radiation is in this category. When in doubt, consult this manual or Hukseflux.

See also:

- BLK – GLD sticker application [instruction video](#) on our YouTube channel
- [FHF05 series](#) general-purpose heat flux sensor
- [FHF05SC series](#) a self-calibrating version of the FHF05 series
- model [HFP01](#) (used on walls and in soils as a lower cost alternative to FHF05 85X85)
- heater [HTR02 series](#), for calibration and verification of performance of FHF-type sensors
- view our complete [range of heat flux sensors](#)



Figure 0.4 Overview of BLK – GLD stickers series: black absorbing stickers and gold reflective stickers matching FHF05 heat flux sensors. They are designed to be applied by the user, but can optionally also be pre-applied at the factory. The figure shows, from left to right, the stickers GLD and BLK on FHF05-10X10, FHF05-15X30, FHF05-50X50, FHF05-15X85 and FHF05-85X85. BLK – GLD sticker series is also available for model HFP01 and FHF05SC series.

1 Ordering and checking at delivery

1.1 Ordering BLK – GLD stickers

The BLK – GLD sticker series is a range of accessories for use with Hukseflux heat flux sensors of FHF05(SC) series and HFP01.

The ordering codes of the different versions in the series are BLK-10X10, BLK-15X30, BLK-50X50, BLK-15X85, BLK-85X85, BLK-80, GLD-10X10, GLD-15X30, GLD-50X50, GLD-15X85, GLD-85X85 and GLD-80.

Table 1.1.1 *Overview of versions in the BLK – GLD sticker series.*

BLK versions	
BLK-10X10	Black absorbing sticker to measure convective + radiative heat flux, to be used with FHF05(SC)-10X10 heat flux sensors
BLK-15X30	Black absorbing sticker to measure convective + radiative heat flux, to be used with FHF05(SC)-15X30 heat flux sensors
BLK-50X50	Black absorbing sticker to measure convective + radiative heat flux, to be used with FHF05(SC)-50X50 heat flux sensors
BLK-15X85	Black absorbing sticker to measure convective + radiative heat flux, to be used with FHF05(SC)-15X85 heat flux sensors
BLK-85X85	Black absorbing sticker to measure convective + radiative heat flux, to be used with FHF05(SC)-85X85 heat flux sensors
BLK-80	Black absorbing sticker to measure convective + radiative heat flux, to be used with HFP01 heat flux sensor
GLD versions	
GLD-10X10	Gold reflective sticker to measure convective heat flux only, to be used with FHF05(SC)-10X10 heat flux sensors
GLD-15X30	Gold reflective sticker to measure convective heat flux only to be used with FHF05(SC)-15X30 heat flux sensors
GLD-50X50	Gold reflective sticker to measure convective heat flux only, to be used with FHF05(SC)-50X50 heat flux sensors
GLD-15X85	Gold reflective sticker to measure convective heat flux only, to be used with FHF05(SC)-15X85 heat flux sensors
GLD-85X85	Gold reflexive sticker to measure convective heat flux only, to be used with FHF05-85X85 heat flux sensors
GLD-80	Gold reflective sticker to measure convective heat flux only, to be used with HFP01 heat flux sensor

A common option is:

- pre-application of the sticker to the sensor(s) of your choice at the factory

When opting for pre-application at the factory, please use the following ordering code:
[product code sensor] – [cable length] - [product code sticker]

example: HFP01-05-GLD-80

for model HFP01 with 5 meters of cable and a pre-applied gold sticker.

1.2 Included items

Arriving at the customer, the delivery should include:

- BLK – GLD sticker version(s) as ordered
- application procedure instruction sheet
- prostrated IPA (Isopropyl Alcohol) wipe

For instructions on how to install/apply the BLK—GLD stickers to your sensor, see the instruction sheet included with your delivery, the instruction movie on our YouTube channel, or clause 6 of this manual.

When opting for pre-applied BLK – GLD stickers, the delivery should include:

- heat flux sensor with sticker applied, with cable of the length as ordered
- product certificate matching the instrument serial number



Figure 1.2.1 *GLD and BLK stickers pre-applied to their matching sensors at the factory.*

2 Instrument principle and theory

2.1 Introduction

The BLK and GLD stickers series are accessories for FHF05 sensors and HFP01 heat flux sensors. These stickers allow the heat flux sensors to measure radiative and convective heat flux separately.

As a first approximation, BLK black stickers absorb all radiation, as Figure 2.1.1 shows.

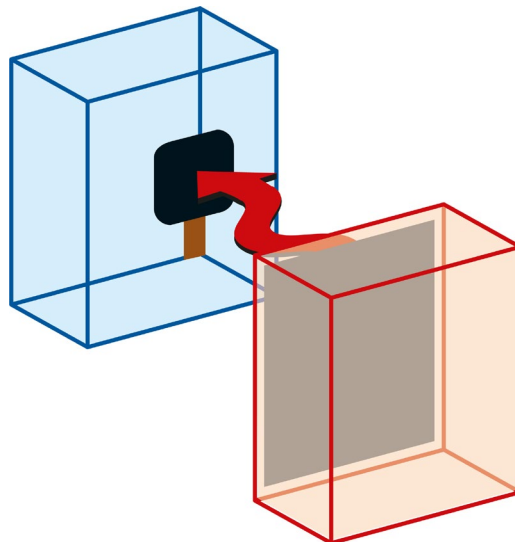

Figure 2.1.1 *BLK black stickers absorb all radiation.*

In contrast to BLK black stickers, GLD gold stickers, as a first approximation, reflect all radiation.

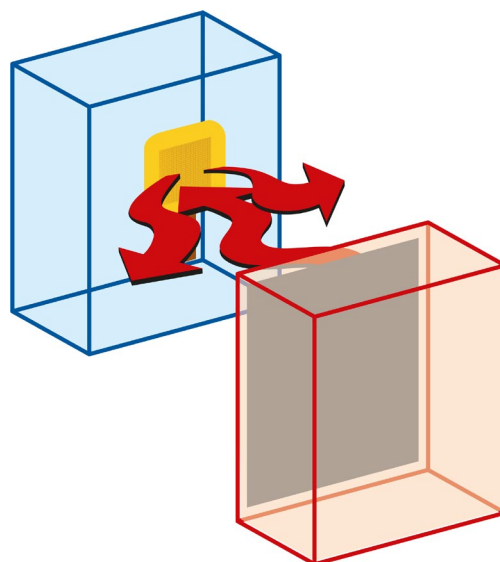

Figure 2.1.2 *GLD gold stickers reflect all radiation.*

BLK black stickers and the GLD gold stickers are both sensitive to convection. See Figure 2.1.3.

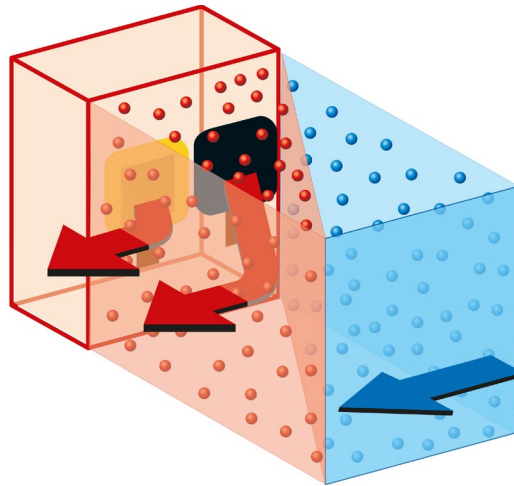

Figure 2.1.3 Both BLK and GLD stickers are sensitive to convective heat flux.

In summary, radiative and convective heat flux are both measured when a black sticker covers the sensor. The heat absorbed and conducted at the surface, is conducted through the heat flux sensor, creating a temperature difference across the thermopile detector inside the heat flux sensor. This thermopile generates a small voltage proportional to the sum of the radiative and convective heat flux.

Radiative heat flux is reflected by the gold sticker, convective heat flux is conducted and measured. The heat conducted at the surface, is conducted through the heat flux sensor, generating a small voltage proportional to the convective heat flux.

The proportionality factor, the ratio of heat flux sensor output voltage to heat flux, is called the sensitivity S in $V/(W/m^2)$. This is determined individually for the heat flux sensor by calibration at the factory and reported on its product certificate.

Applying a sticker to a heat flux sensor does not change the sensitivity of the heat flux sensor.

2.2 Normal use: moderate-accuracy and comparative measurements

As a first approximation, you may assume that both sensors are at the same temperature and have perfect absorption and emission of radiative heat fluxes. This approach leads to moderate-accuracy results. These may be sufficient for the average user.

This moderate-accuracy approach is also often used to compare two situations, for example with a source switched [on] or [off]. Furthermore, it is useful to estimate orders of magnitude of heat flux as a starting point for high-accuracy measurements.

For moderate-accuracy measurements the following formulas are used:

$$\Phi_{\text{radiative}} + \Phi_{\text{convective}} = \Phi_{\text{total}} = \Phi_{\text{BLK}} \quad (2.1.1)$$

$$\Phi_{\text{convective}} = \Phi_{\text{GLD}} \quad (2.1.2)$$

$$\Phi_{\text{radiative}} = \Phi_{\text{BLK}} - \Phi_{\text{GLD}} \quad (2.1.3)$$

The heat flux Φ in W/m^2 passing through- and measured by a heat flux sensor is

$$\Phi = U/S \quad (2.1.4)$$

where [U] is the heat flux sensor voltage output, and [S] the sensitivity found on the sensor calibration certificate.

Chapter 3 explains what should be done to attain a high-accuracy measurement.

3 Advanced use: high-accuracy measurements

3.1 Introduction

The following sections explain what should be done to attain a high-accuracy measurement with BLK and GLD stickers.

For high accuracy measurement it is essential to understand that:

- absorption and reflection of both BLK and GLD stickers may not be perfect.
- a sensor with a BLK black sticker not only receives radiation, but also emits radiation depending on its own temperature. What is measured is the net result of incoming and emitted radiation.
- the surface temperature of a sensor is not the same as the measured temperature. The difference between the measured sensor body and heat sink temperature depends on the heat flux. The difference can be calculated from temperature, heat flux and thermal resistance of the sensor. At high heat fluxes, this temperature difference is significant.
- the sensitivity of a heat flux sensor is not a constant. It changes with temperature. Calibration is performed at 20 °C. At operating temperatures far away from the calibration temperature, you may compensate for this effect.
- radiation of high colour-temperature sources is not perfectly reflected by the GLD sensor.

Section 3.2 gives more details on the BLK and GLD spectral properties. The further sections treat typical mathematical treatment of measurement results to compensate for the above effects.

3.2 Spectral properties of BLK and GLD stickers

In high-accuracy measurement, you may correct for non-perfect absorption and emission. This section gives the numbers to work with. See also the appendix on the subject.

3.2.1 Reflection

In an ideal scenario, a black sticker reflects no radiation across all wavelengths and a gold sticker reflects all radiation across all wavelengths. In reality, the reflection of both stickers depends on the wavelength of the incoming radiation.

The BLK black sticker has an average reflection of 3 % ($r_{\text{BLK}} = 0.03$) in the UV, visible, near-infrared and far-infrared spectrum.

The GLD gold sticker has a reflection of about 35 % ($r_{\text{GLD}} = 0.35$) in the UV spectrum, which increases through the visible spectrum to an average reflection value of 98 % ($r_{\text{GLD}} = 0.98$) in the near-infrared and the far-infrared.

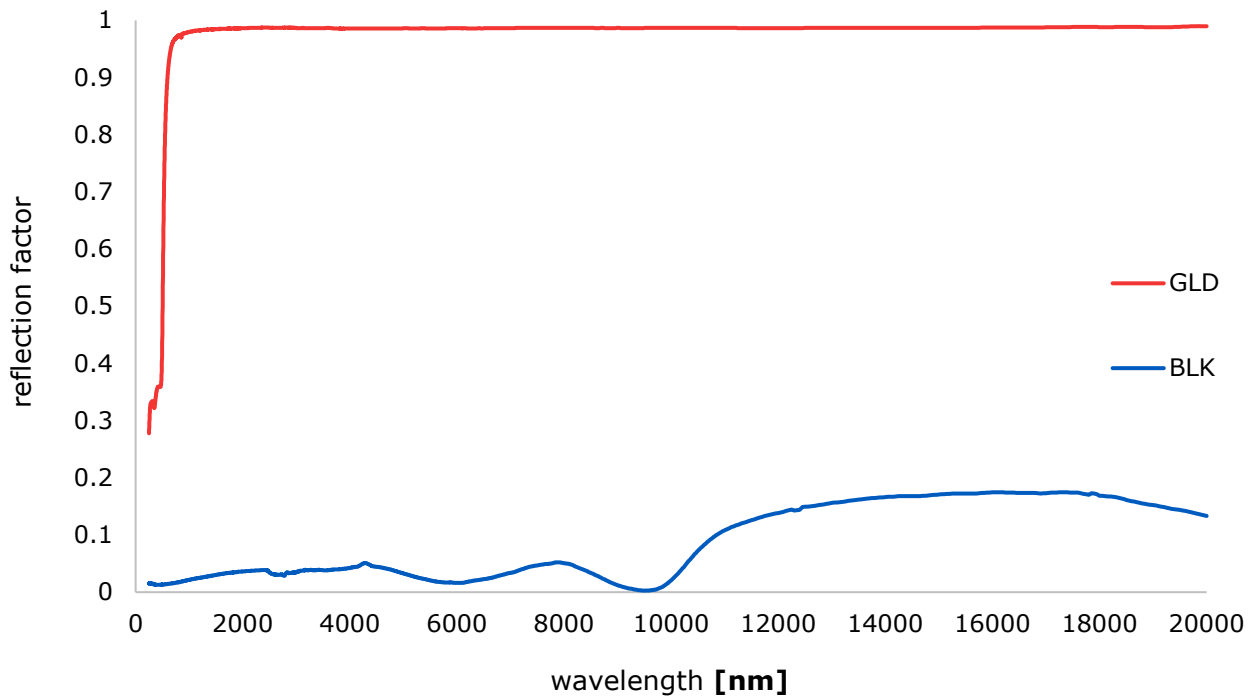

Figure 3.2.1.1 *BLK and GLD reflection factors as a function of wavelength.*

Typical values of the average reflection factors for common radiation sources are given in Table 3.2.1.1.

For more details on spectral properties of the stickers, see the Appendix on the subject.

Table 3.2.1.1 *Typical reflection factor for common radiation sources.*

RADIATION SOURCE	r_{BLK}	r_{GLD}
UV radiation	0.02	0.35
Solar radiation, Xenon lamps (colour temperature 6000 K)	0.02	0.80
Halogen and infrared lamps, industrial heaters (colour temperature < 4000 K)	0.03	0.97
Low-temperature infrared sources such as radiant heaters, stoves, 300 to 600 °C	0.05	0.99
Objects at room temperature, - 40 to + 70 °C	0.11	0.99

3.2.2 absorption and emissivity

In certain applications, absorption and emissivity are the relevant spectral properties instead of reflection.

Absorption α is the amount of energy absorbed by an object.

$$\alpha_{BLK} = 1 - r_{BLK} \tag{3.2.2.1}$$

$$\alpha_{GLD} = 1 - r_{GLD} \tag{3.2.2.2}$$

Emissance is the amount of thermal energy emitted by an object. Numerically, emissivity is the same as absorption.

$$\epsilon_{BLK} = \alpha_{BLK} \tag{3.2.2.3}$$

$$\epsilon_{GLD} = \alpha_{GLD} \tag{3.2.2.4}$$

Table 3.2.2.1 Typical absorption factors for common radiation sources.

RADIATION SOURCE	α_{BLK}	α_{GLD}
UV radiation	0.98	0.65
Solar radiation, Xenon lamps (colour temperature 6000 K)	0.98	0.20
Halogen and infrared lamps, industrial heaters (colour temperature < 4000 K)	0.97	0.03
Low-temperature infrared sources such as radiant heaters, stoves, 300 to 600 °C	0.95	0.01
Objects at room temperature, - 40 to + 70 °C	0.89	0.01

3.3 BLK and GLD sensors on the same heat sink

If possible, we recommend mounting the two sensors, BLK and GLD, on the same heat sink. This makes analysis easy because then they have - at least approximately, which is sufficient - the same temperature, and thus:

$$T_{BLK} = T_{GLD} \tag{3.3.1}$$

To measure radiative and convective heat flux, preferably:

- apply a BLK black sticker on a heat flux sensor.
- apply a GLD gold sticker on another heat flux sensor.
- place the two heat flux sensors side by side, on the same heat sink so that they have the same heat sink (and sensor) temperature.
- a heat sink may be a metal plate, for example, an aluminium plate of at least 1 mm thickness, or, in case a larger heat capacity is required, a thicker plate. We then assume there is no significant temperature difference of the heat sink between sensors (difference < 2 °C).

Measure:

- T_{amb} , ambient air temperature.
- T_{GLD} , the heat sink temperature.
- Φ_{BLK} , heat flux measured by the black heat flux sensor (output voltage divided by sensitivity).
- Φ_{GLD} , heat flux measured by the gold heat flux sensor (output voltage divided by sensitivity).

Typical boundary conditions to keep in mind are:

- valid measurements require steady state conditions: temperature and flux do not change.
- no solar radiation or other sources with high colour temperature (see the section on working with high-temperature sources / solar radiation).
- heat fluxes below a level where surface temperature significantly increases (see the section on correction of sensor surface temperature).
- spectral corrections are made based on the tables in the section about spectral properties).
- sensor temperatures at a level where temperature dependence is not corrected (see appendix on temperature dependence).

Applying a sticker does not alter the working principle of the heat flux sensor. The original sensitivity S , as specified on the sensor calibration certificate, is still valid.

For most VIS, IR and FIR radiation sources the GLD sticker is a perfect reflector. This does not apply to solar and Xenon lamp sources (see Tables in 3.2). In case the sources have a low colour temperature, lower than 1000 °C, we assume that the reflection factor of GLD, while actually 0.99, is 1. See the section on sources with high colour temperature and the appendix on reflection and absorption how to deal with exceptional sources.

$$r_{GLD} = 1 \quad (3.3.2)$$

The heat flux Φ in W/m² passing through- and measured by a heat flux sensor is

$$\Phi = U/S \quad (3.3.3)$$

where [U] is the heat flux sensor voltage output, and [S] the sensitivity found on the sensor calibration certificate.

3.3.1 Measurement of convective flux

The purpose is to calculate the convective heat flux $\Phi_{\text{convective}}$:

- transferred by ambient air at a certain temperature and speed
- to an object at the heat flux sensor location
- to an object at the heat flux sensor temperature
- to an object in the heat flux sensor plane (same surface orientation)

The heat flux due to convection is measured by the GLD sensor.

$$\Phi_{\text{convective}} = \Phi_{\text{GLD}} = U_{\text{GLD}}/S_{\text{GLD}} \quad (3.3.1.1)$$

3.3.2 Characterising a convective source: T_{air} and heat transfer coefficient C_{tr}

Properties of a convective source are the convective ambient air temperature T_{air} and the convective heat transfer coefficient C_{tr} . Knowing C_{tr} , the convective heat transfer to a similarly oriented surface of any surface temperature in the same airflow may be calculated.

Note that the convective heat transfer coefficient C_{tr} is not a function of the sensor temperature, because the $\Phi_{\text{convective}}$ is proportional to the difference ($T_{\text{air}} - T_{\text{GLD}}$). C_{tr} is a function of:

- air speed and
- the interaction of the sensor surface with the air (orientation of the surface)

$$C_{\text{tr}} = \Phi_{\text{convective}}/(T_{\text{air}} - T_{\text{GLD}}) \quad (3.3.2.1)$$

Expected measured values of the heat transfer coefficient for air are in the range of 5 to 20 W/(m²·K) for natural thermal convection and up to 100 W/(m²·K) for forced convection.

The convective heat transfer to a similarly oriented surface in the same airflow is:

$$\Phi_{\text{convective, surface}} = C_{\text{tr}}(T_{\text{air}} - T_{\text{surface}}) \quad (3.3.2.2)$$

3.3.3 Measurement of incoming radiative flux

The purpose is to calculate the radiative heat flux Φ_{incoming}

- emitted by the source
- incoming to an object at the heat flux sensor location
- to an object in the heat flux sensor plane (same surface orientation)

As a first approximation, we assume that the heat transfer by convection to the BLK and GLD sensors is identical, because their surface temperatures are the same, see 2.2.

$$\Phi_{\text{convective}} = \Phi_{\text{convective BLK}} = \Phi_{\text{convective GLD}} \quad (3.3.3.1)$$

The measured radiative flux Φ_{BLK} is a net heat flux consisting of incoming flux from the source, corrected for the absorption of the BLK coating $\alpha_{\text{BLK, incoming}}$ for incoming radiation Φ_{incoming} from the source at T_{source} minus the (blackbody) radiation emitted by the sensor at T_{BLK} , corrected for the emission of the BLK coating, $\epsilon_{\text{BLK, emitted}}$.

The net heat flux by radiation as measured by the BLK sensor

$$\Phi_{\text{radiative BLK}} = \Phi_{\text{BLK}} - \Phi_{\text{convective GLD}} = (U_{\text{BLK}}/S_{\text{BLK}}) - (U_{\text{GLD}}/S_{\text{GLD}}) \quad (3.3.3.2)$$

and

$$\Phi_{\text{radiative BLK}} = \alpha_{\text{BLK, incoming}} \cdot \Phi_{\text{incoming}} - \sigma \cdot \epsilon_{\text{BLK, emitted}} \cdot (T_{\text{BLK}} + 273)^4 \quad (3.3.3.3)$$

This gives us the following formula to calculate the incoming flux:

$$\Phi_{\text{incoming}} = (\Phi_{\text{radiative BLK}} + \sigma \cdot \epsilon_{\text{BLK, emitted}} \cdot (T_{\text{BLK}} + 273)^4) / \alpha_{\text{BLK, incoming}} \quad (3.3.3.4)$$

3.3.3.1 Example 1: working around room temperature:

Consider the following boundary conditions:

$$-40 \text{ }^\circ\text{C} < (T_{\text{BLK}}, T_{\text{source}}) < 70 \text{ }^\circ\text{C} \quad (3.3.3.1.1)$$

We assume (see appendix on absorption and reflection):

$$\epsilon_{\text{BLK, emitted}} = \alpha_{\text{BLK, incoming}} = 0.89 \quad (3.3.3.1.2)$$

so that

$$\Phi_{\text{incoming}} = 1.12 \cdot \Phi_{\text{radiative BLK}} + \sigma \cdot (T_{\text{BLK}} + 273)^4 \quad (3.3.3.1.3)$$

3.3.3.2 Example 2: sensor at room temperature and a uniform infra-red source

Consider the following boundary conditions:

$$-40 \text{ }^\circ\text{C} < T_{\text{BLK}} < 70 \text{ }^\circ\text{C}, \quad (3.3.3.2.1)$$

$$300 \text{ }^\circ\text{C} < T_{\text{source}} < 600 \text{ }^\circ\text{C} \quad (3.3.3.2.2)$$

We assume:

$$\varepsilon_{\text{BLK, emitted}} = 0.89 \quad (3.3.3.2.3)$$

$$\alpha_{\text{BLK, incoming}} = 0.95 \quad (3.3.3.2.4)$$

and

$$\Phi_{\text{incoming}} = (1.05 \cdot \Phi_{\text{radiative BLK}} + 0.94 \cdot \sigma \cdot (T_{\text{BLK}} + 273)^4) \quad (3.3.3.2.5)$$

3.3.4 Characterising a radiative source: $T_{\text{blackbody}}$ equivalent blackbody temperature

The equivalent blackbody source temperature assumes that the heat flux sensors face

- an imaginary, uniform blackbody source
- over its full 180 ° field of view angle (or more correctly: 2π sr solid angle)
- with an emission of 1

$$\varepsilon_{\text{source}} = 1 \quad (3.3.4.1)$$

The heat exchange is described by:

$$\sigma \cdot \varepsilon_{\text{source}} \cdot (T_{\text{blackbody}} + 273)^4 = (\Phi_{\text{radiative}} + \sigma \cdot \varepsilon_{\text{BLK, emitted}} \cdot (T_{\text{BLK}} + 273)^4) / \alpha_{\text{BLK, incoming}} \quad (3.3.4.2)$$

The equivalent blackbody source temperature is:

$$T_{\text{blackbody}} = ((\Phi_{\text{radiative}} + \sigma \cdot \varepsilon_{\text{BLK, emitted}} \cdot (T_{\text{BLK}} + 273)^4) / (\sigma \cdot \varepsilon_{\text{source}} \cdot \alpha_{\text{BLK, incoming}}))^{1/4} - 273 \quad (3.3.4.3)$$

3.4 BLK and GLD sensors at different temperatures

In case T_{BLK} and T_{GLD} differ by more than 2 °C, this may have a significant impact on convective heat exchange:

$$|T_{\text{BLK}} - T_{\text{GLD}}| > 2 \quad (3.4.1)$$

equation 3.3.3.2 must be corrected for differences in convective heat flux:

$$\begin{aligned} \Phi_{\text{radiative}} &= \Phi_{\text{BLK}} - \Phi_{\text{convective GLD}} \\ &= (U_{\text{BLK}}/S_{\text{BLK}}) - (U_{\text{GLD}}/S_{\text{GLD}}) \cdot ((T_{\text{air}} - T_{\text{BLK}})/(T_{\text{air}} - T_{\text{GLD}})) \end{aligned} \quad (3.4.2)$$

From then on, the other equations of 3.3.3 may be used, possibly with the optional corrections of 3.5 and 3.6.

3.5 Surface temperature correction at high flux levels

A similar correction as in 3.4 should also be considered when there is a large heat flux. In that case, the sensor surfaces may be hotter than the temperature measurement of the heat sink on which the sensors are mounted. The correction depends on the heat flux Φ through the sensor and on the thermal resistance, $R_{\text{thermal,A}}$, between the point at which the temperature is measured to the sensor surface.

Taking the BLK sensor as an example:

$$T_{\text{BLK, corrected}} = T_{\text{BLK}} + \Phi_{\text{BLK}} \cdot R_{\text{thermal,A, BLK}} \quad (3.5.1)$$

$$= T_{\text{BLK}} + (U_{\text{BLK}}/S_{\text{BLK}}) \cdot R_{\text{thermal,A, BLK}} \quad (3.5.2)$$

As in 3.4, we recommend correction if the difference between the corrected and measured temperature is more than 2 °C.

Use correction if:

$$|(U_{\text{BLK}}/S_{\text{BLK}}) \cdot R_{\text{thermal,A, BLK}}| > 2 \quad (3.5.3)$$

3.5.1 Example: high heat flux correction with FHF05 series

A FHF05 model with a BLK or GLD sticker the thermal resistance is:

$$R_{\text{thermal,A}} = R_{\text{thermal,A, sensor}} + R_{\text{thermal,A, sticker}} = (11 + R_{\text{thermal,A, sticker}}) \times 10^{-4} \quad (3.5.1.1)$$

The location of the temperature in the sensor is close to the surface where the sticker is applied. Roughly, this is at 1/6th of the total sensor thickness (0.4×10^{-3} m). The total thermal resistance of the sensor is: $R_{\text{thermal,A, sensor}} = 11 \times 10^{-4}$ K/(W/m²). To account for the location of the temperature probe, a value of $R_{\text{thermal,A, sensor temp location}} = 2 \times 10^{-4}$ K/(W/m²) is taken.

The thermal resistance of the stickers is: $R_{\text{thermal,A, sticker BLK}} = 10 \times 10^{-4}$ K/(W/m²) and $R_{\text{thermal,A, sticker GLD}} = 3.5 \times 10^{-4}$ K/(W/m²).

For a FHF05 model with a BLK sticker, the thermal resistance between the front surface and the location of the thermocouple is:

$$R_{\text{thermal,A, sensor with BLK}} = (2 + 10) \times 10^{-4} \quad (3.5.1.2)$$

And for a FHF05 model with a GLD sticker, the thermal resistance between the front surface and the location of the thermocouple is:

$$R_{\text{thermal,A, sensor with GLD}} = (2 + 3.5) \times 10^{-4} \quad (3.5.1.3)$$

And the corrected temperature for the sensor with BLK sticker becomes:

$$T_{\text{BLK, corrected}} = T_{\text{BLK}} + 12 \times 10^{-4} \cdot \Phi_{\text{BLK}} \quad (3.5.1.4)$$

$$= T_{\text{BLK}} + 12 \times 10^{-4} \cdot (U_{\text{BLK}}/S_{\text{BLK}}) \quad (3.5.1.5)$$

The corrected temperature for the sensor with GLD sensor becomes:

$$T_{\text{GLD, corrected}} = T_{\text{GLD}} + 5.5 \times 10^{-4} \cdot \Phi_{\text{GLD}} \quad (3.5.1.6)$$

$$= T_{\text{GLD}} + 5.5 \times 10^{-4} \cdot (U_{\text{GLD}}/S_{\text{GLD}}) \quad (3.5.1.7)$$

For FHF05 we recommend correcting if:

$$12 \times 10^{-4} \cdot (U_{\text{BLK}}/S_{\text{BLK}}) > 2 \text{ } ^\circ\text{C} \quad (3.5.1.8)$$

$$5.5 \times 10^{-4} \cdot (U_{\text{GLD}}/S_{\text{GLD}}) > 2 \text{ } ^\circ\text{C} \quad (3.5.1.9)$$

or

$$\Phi_{\text{BLK}} > 1667 \text{ W/m}^2 \quad (3.5.1.10)$$

$$\Phi_{\text{GLD}} > 3635 \text{ W/m}^2 \quad (3.5.1.11)$$

In that case, 3.3.3.2 becomes:

$$\begin{aligned} \Phi_{\text{radiative}} &= \Phi_{\text{BLK}} - \Phi_{\text{convective GLD}} \\ &= (U_{\text{BLK}}/S_{\text{BLK}}) - (U_{\text{GLD}}/S_{\text{GLD}}) \cdot ((T_{\text{air}} - T_{\text{BLK, corrected}})/(T_{\text{air}} - T_{\text{GLD}})) \end{aligned} \quad (3.5.1.12)$$

3.6 Optional correction for sensor temperature dependence

The sensitivity of a heat flux sensor depends on the temperature of the sensor. For example, the temperature dependence of the FHF05 series is specified as $< 0.2 \text{ \%/}^\circ\text{C}$. At higher temperatures, sensors usually are more sensitive. The order of magnitude is the same for other sensor models. See the product manuals for up-to-date estimates of temperature dependence for your sensor model.

The calibration reference temperature for Hukseflux sensors is $20 \text{ }^\circ\text{C}$.

Temperature dependence may be corrected. This is worthwhile only if the error is of the same order as calibration uncertainty, i.e., correction is recommended only if the correction $> 4 \text{ \%}$.

Apply corrections in case:

$$T_{\text{sensor}} < 0 \text{ }^\circ\text{C}, \quad (3.6.1)$$

or

$$T_{\text{sensor}} > 40 \text{ }^\circ\text{C} \quad (3.6.2)$$

3.6.1 Correction of temperature dependence of the FHF05 series

The sensitivity of an FHF05 sensor depends on the temperature of the sensor. The temperature dependence of the FHF05 series is specified as $< 0.2 \text{ \%/}^\circ\text{C}$.

The calibration reference temperature is $20 \text{ }^\circ\text{C}$.

Users who measure at temperatures that deviate much from $20 \text{ }^\circ\text{C}$ or who measure over a wide range of temperatures may wish to correct for this temperature dependence.

To correct for the temperature dependence of the sensitivity, use the following measurement function

$$\Phi = U / (S \cdot (1 + 0.002 \cdot (T - 20))) \quad (3.6.1.1)$$

with Φ the heat flux in W/m^2 , U the FHF05 series voltage output in V , S the sensitivity in $\text{V}/(\text{W/m}^2)$ at $20 \text{ }^\circ\text{C}$ and T the FHF05 temperature. The coefficient of 0.002 or 0.2 [\%/K] is the best estimate Hukseflux currently has of the temperature dependence of sensitivity.

S is shown on the product certificate and at the end of FHF05's cable.

3.7 Working with high colour temperature sources; the Sun, Xenon lamps

The colour temperature of solar radiation and of Xenon lamps is around 6000 K. For this spectrum, the GLD sticker is no longer a perfect reflector.

Heat flux of a direct solar beam on a clear sunny day may be in the order of 1000 W/m².

The absorption of GLD is 20 %, that of BLK 98 %, see section 2.2.

To correct for incoming solar radiation, use a pyranometer mounted in the same plane as the heat flux sensor to correct the data. A pyranometer measures the solar heat flux Φ_{solar} in W/m².

If a pyranometer is not available, Φ_{solar} may be estimated by carrying out an experiment shading and unshading the black sensor, as described in section 4.2.

Equation 3.3.1.1 is then corrected:

$$\Phi_{\text{convective}} = \Phi_{\text{GLD}} - 0.20 \cdot \Phi_{\text{solar}} \quad (3.7.1)$$

$$\Phi_{\text{radiative BLK}} = \Phi_{\text{BLK}} - \Phi_{\text{convective}} - 0.98 \cdot \Phi_{\text{solar}} \quad (3.7.2)$$

4 Examples of BLK and GLD in use

4.1 Outgoing radiation heat flux on metallic / reflective surfaces

Every object emits radiation. Only very hot objects, hotter than 400 °C, emit radiation that is visible to the eye. Although not visible, heat flux sensors with BLK stickers emit a significant amount of radiative energy too, while GLD stickers have a low emission so that the emitted radiation is negligible.

In general: when performing measurements of emitted radiation from a surface, use a heat flux sensor with a sticker that matches the emissivity of the surface.

Most non-metallic surfaces, although they may have different colours (VIS spectral range visible radiation for the human eye), are perfectly “black” in the FIR Far Infra-red; in other words, perfect absorbers ($r = 0$) / emitters ($\epsilon = 1$). Metal surfaces are reflectors (also having a low emission) in VIS as well as FIR. Partial absorption in the FIR may be found in corroded or non-polished metal.

In this example, we show that if you wish to measure radiation losses of a polished metal surface, you get a representative measurement using a GLD sticker.

In Figure 4.1.1, two sensors, one with a BLK sticker and one with a GLD sticker are mounted on the surface of an espresso machine. The surface temperature of the polished stainless-steel surface is approximately 45 °C.

The GLD sticker on the right has an emissivity like that of the espresso machine’s polished metal surface. This can be seen using an infrared camera; both the GLD sensor and the metal surface appear bluish on the thermal image, having an apparent temperature of 35 °C. The camera actually makes an error in its temperature measurement, because both surfaces do not emit radiation, have an emission close to 0, while the camera assumes an emission of 1 for all surfaces. The actual temperature can be estimated from the image taken of the BLK sensor, which has a near-perfect emission ϵ_{BLK} of 1 and which appears to be 45 °C. Both are mounted on the same metal plate, so we assume that the GLD sensor has the same temperature.

The camera shows that the emissivity of the GLD sticker matches the emissivity of the stainless-steel surface reasonably well. A heat flux sensor with a GLD sticker will therefore give a better approximation of the heat flux from the espresso machine’s metal surface than a sensor with a BLK sticker.

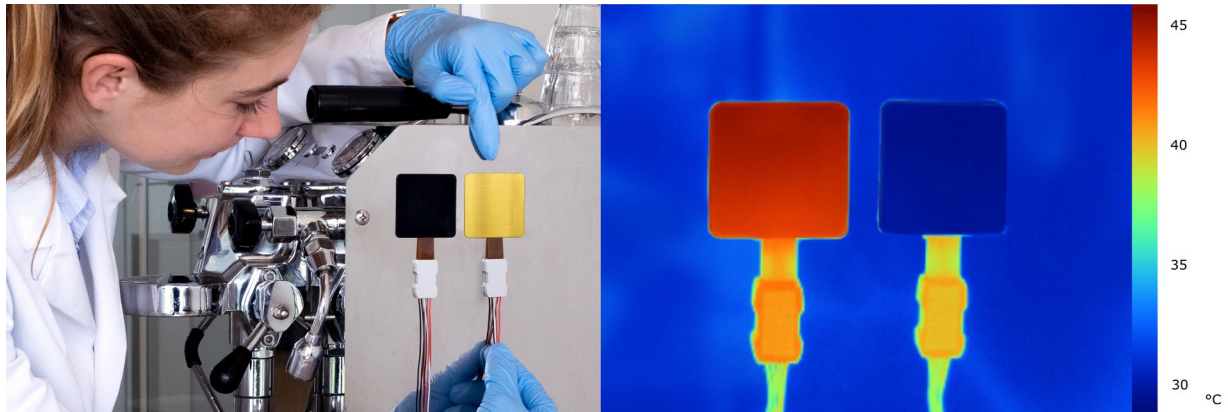

Figure 4.1.1 *Measuring with BLK – GLD stickers; application of a BLK black sticker and a GLD gold sticker on FHF models for measuring radiative and convective heat flux on an espresso machine. The machine has a polished metal surface of about 45 °C. The IR image on the right shows that the black sticker on the left, as well as the sensor wires and connector cable connection blocks, emit radiation. They appear in red on the image. The gold sticker and the metal surface have lower emission and appear as “bluish” on the image. Mounted on the same surface, the BLK and GLD stickers have the same temperature. The measurement with the sensor with the GLD sticker is most representative of the heat flux at the polished metal surface, while the sensor with the BLK sticker overestimates the heat flux. The sensor tabs, cable connection blocks and cable are not connected to the metal plate and have a temperature between that of the metal and ambient air.*

Users could also choose to attribute a theoretical emission to the stainless steel and estimate the radiation loss using the formula of 3.3:

$$\Phi_{\text{radiative BLK}} = \Phi_{\text{BLK}} - \Phi_{\text{convective}} = (U_{\text{BLK}}/S_{\text{BLK}}) - (U_{\text{GLD}}/S_{\text{GLD}}) \quad (4.1.1)$$

and

$$\Phi_{\text{radiative, stainless steel}} = (\epsilon_{\text{stainless steel}} / \epsilon_{\text{BLK}}) \Phi_{\text{radiative BLK}} \quad (4.1.2)$$

4.2 Sources covering part of the sensor field of view; the view factor

In case a radiating source does not occupy the full field of view, solid angle of 2π steradian, of a flat heat flux sensor, it is possible to express the irradiance received by the sensor in terms of an optical view factor, f .

To calculate the radiative heat flux Φ_{incoming}

- emitted by the source,
- incoming at the heat flux sensor location
- in the heat flux sensor plane

$$\Phi_{\text{incoming}} = \sigma \cdot f \cdot \epsilon_{\text{source}} \cdot (T_{\text{source}} + 273)^4 \quad (4.2.1)$$

For example, assuming that the sensors can be represented as a point under the source, for the round infra-red radiator in Figure 4.2.1 below, the view factor, f , is determined with

$$f = \sin(\theta)^2 \quad (4.2.2)$$

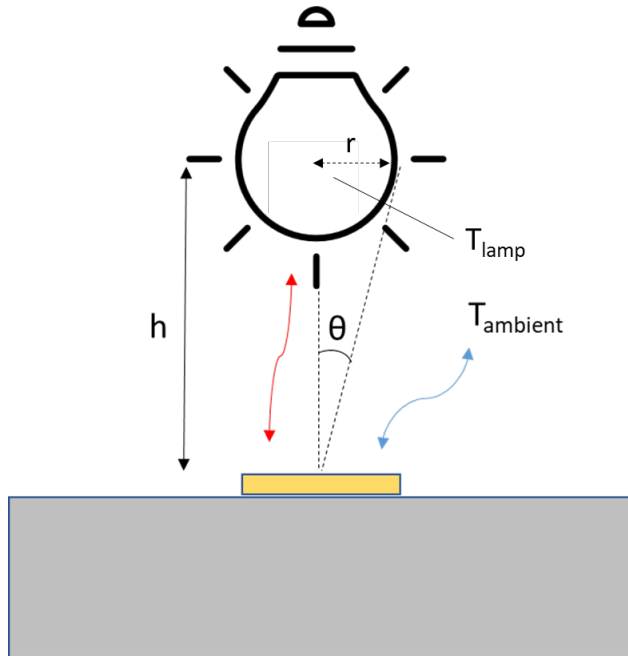

Figure 4.2.1 Measuring radiative heat flux of a round source (as seen from the heat flux sensor). The sensor is situated on a heat sink at T_{sensor} . The source does not fully occupy the full field of view of the sensors. Radiation from the source originates from an angle θ .

Assuming that all emission coefficients are 1, the total incoming heat flux of the radiation from the source and ambient origin at the sensors is:

$$\Phi_{incoming} = \sigma \cdot f \cdot (T_{source} + 273)^4 + \sigma \cdot (1 - f) \cdot (T_{ambient} + 273)^4 \quad (4.2.3)$$

The radiative flux measured by a BLK sensor is:

$$\Phi_{radiative} = \Phi_{BLK} - \Phi_{convective\ GLD} = (U_{BLK}/S_{BLK}) - (U_{GLD}/S_{GLD}) \quad (4.2.4)$$

$$\Phi_{radiative} \text{ [SOURCE ON]} = \quad (4.2.5)$$

$$f \cdot \alpha_{BLK, T_{source}} \cdot \Phi_{radiative, source} + (1-f) \cdot \alpha_{BLK, T_{ambient}} \cdot \Phi_{radiative, ambient} - \sigma \cdot \epsilon_{BLK, emitted} \cdot (T_{BLK} + 273)^4$$

The heat flux of the source can only be measured by switching the source off, and assuming the source then also returns to ambient temperature:

$$\Phi_{\text{radiative}} [\text{SOURCE OFF}] = \alpha_{\text{BLK, T}_{\text{ambient}}} \cdot \Phi_{\text{radiative, ambient}} - \sigma \cdot \epsilon_{\text{BLK, emitted}} \cdot (T_{\text{BLK}} + 273)^4 \quad (4.2.6)$$

$$\Phi_{\text{radiative, incoming, source}} = \quad (4.2.7)$$

$$(\Phi_{\text{radiative}} [\text{SOURCE ON}] - \Phi_{\text{radiative}} [\text{SOURCE OFF}] + f \cdot \alpha_{\text{BLK, T}_{\text{ambient}}} \cdot \Phi_{\text{radiative, ambient}})$$

$$/ \alpha_{\text{BLK, T}_{\text{source}}}$$

In case f is sufficiently small, indicating that only a small portion of the ambient space is occupied by the source, or in case the radiative flux from ambient sources to the sensor is small because T_{BLK} is close to T_{ambient} , the term $f \cdot \alpha_{\text{BLK, T}_{\text{ambient}}} \cdot \Phi_{\text{radiative, ambient}}$ may be ignored. Then

$$\Phi_{\text{radiative, incoming, source}} = (\Phi_{\text{radiative}} [\text{SOURCE ON}] - \Phi_{\text{radiative}} [\text{SOURCE OFF}]) / \alpha_{\text{BLK, T}_{\text{source}}} \quad (4.2.8)$$

4.3 Heat flux measurement to characterise ovens, thermal profiling

4.3.1 General principles

Heat flux sensors are frequently applied to characterise ovens, for example in the baking industry or in ovens used for production and curing of rubber insulation foams. In such applications, a BLK and a GLD sensor and a thermally insulated data logger are placed on the conveyor belt in the oven. They move through the oven at a speed representative of the normal production process, sometimes along with the product.

This process of characterisation is called Thermal Profiling, TP.

The purposes of TP may be:

- characterisation of the heat transfer in the oven
- quantifying and separating the effects of heating by air and heating by radiation
- establishing a fingerprint or reference thermal profile, not aiming at accurate heat transfer measurement. This fingerprint can later be used as a baseline. This is useful when servicing ovens, when trying to copy oven settings from one oven to another, for fault-finding, and to compare to similar processes elsewhere.

The parameters typically measured are:

- air temperature, [T_{air}]
- sensor body temperature [T_{sen}]
- total heat flux (BLK sensor) [Φ_{total}]
- convective heat flux (GLD sensor) [$\Phi_{\text{convective}}$]

Derived parameters are:

- air temperature
- local airspeed, expressed as the heat transfer coefficient [C_{tr}] (characterising heating by air)
- local equivalent blackbody temperature, or incoming radiative heat flux (characterising heating by radiation) [$T_{\text{blackbody}}$]

In some cases, it is sufficient for comparative purposes only, to establish a fingerprint using only a single BLK sensor. In that case, the purpose is:

- establish a total heat flux profile (radiative + convective) with a “reference sensor”.

To produce reproducible results, it is beneficial if:

- the reference sensors used for comparison have the same standardised geometry and heat capacity
- measurement in different experiments is started at the same standardised sensor body temperature

Points of attention in the TP measurement are:

- be careful with ambient air temperature measurements; temperature sensors may heat up by radiative sources that are often part of ovens. In that case, they no longer measure the true ambient air temperature. We recommend shielding the ambient air temperatures from radiation, or using gold-plated ambient air temperature sensors.
- be careful to avoid condensation of fluids (water vapour) on the heat flux sensor. Heat the sensor to above any local dew point (in the oven) before entering the oven and starting the measurement. Condensation may be recognised by a sudden increase of heat flux in a high-humidity area, followed by decreasing flux or even negative flux when the fluid evaporates.
- the sensor response time must match that of the process. In case transport belts move too fast relative to the radiative and convective sources, the sensor may not be able to register details of the process. On the other hand, in many applications this may not matter; the heat flux integrated over time in [J/m^2] will still be representative.
- a heat flux sensor behaves as a simple first-order system; it can be described using a single time constant. The response time of such sensors may mathematically be improved by a factor 2 (made shorter), in data post-processing.

- synchronisation of BLK and GLD sensors may be an issue. Make sure they are exposed to the same source at the same time or introduce a time lag in post-processing.
- sensors must not overheat. The maximum temperature of the sensor's top surface is a function of the temperature of the heat sink, to which the bottom of the sensor is connected, plus a temperature difference between the bottom and top surface of the sensor generated by the local heat flux. Typical measures to limit overheating are starting the experiment with a low heat sink temperature, using a heat sink with a high heat capacity, thermally insulating the heat sink, or using a heat sink that reflects radiation. For FHF sensors the maximum rated operating temperature for continuous use is 120 °C. TP experiments are typically short-term (< 30 min) only, and some users choose to accept 150 °C as the maximum rated temperature.
- products processed in industrial ovens may also gain heat from the conveyor belt; in some cases, "belt temperature" is measured as well.
- users may try to estimate which part of heat transported to the product processed in industrial ovens is radiative and which part is convective. Please note that this estimate is qualitative only because both the convective and radiative heat flux levels and the ratio between these two depend on the product surface temperature. The heat flux sensor surface temperature may not be representative.

4.3.2 Equations typically applied in TP experiments with FHF05 series

To determine the main measured quantities T_{air} , $\Phi_{incoming}$, C_{tr} and the equivalent blackbody temperature $T_{source, blackbody}$.

Temperature-corrected heat fluxes measured by BLK and GLD sensors:

$$\Phi_{GLD} = U_{GLD} / (S_{GLD} \cdot (1 + 0.002 \cdot (T_{GLD} - 20))) \quad (4.3.2.1)$$

$$\Phi_{BLK} = U_{BLK} / (S_{BLK} \cdot (1 + 0.002 \cdot (T_{BLK} - 20))) \quad (4.3.2.2)$$

Surface temperatures of BLK and GLD sensors are measured temperatures corrected for heat flux and the thermal resistance of the sensors. Usually, but not always, the measured temperatures T_{BLK} and T_{GLD} are identical, as they are mounted on the same metal heat sink.

In case we use FHF series sensors:

$$T_{BLK, corrected} = T_{BLK} + 12 \times 10^{-4} \cdot \Phi_{BLK} \quad (4.3.2.3)$$

$$T_{GLD, corrected} = T_{GLD} + 5.5 \times 10^{-4} \cdot \Phi_{GLD} \quad (4.3.2.4)$$

The heat transfer coefficient:

$$C_{tr} = \Phi_{GLD} / (T_{air} - T_{GLD, corrected}) \quad (4.3.2.5)$$

The radiative part $\Phi_{\text{radiative}}$ of the total flux Φ_{BLK}

$$\begin{aligned}\Phi_{\text{radiative}} &= \Phi_{\text{BLK}} - \Phi_{\text{convective}} \\ &= U_{\text{BLK}} / (S_{\text{BLK}} \cdot (1 + 0.002 \cdot (T_{\text{BLK}} - 20))) - C_{\text{tr}} \cdot (T_{\text{air}} - T_{\text{BLK, corrected}})\end{aligned}\quad (4.3.2.6)$$

In case the sensor remains at a relatively low temperature and the source is an infra-red lamp,

$$-40 \text{ }^\circ\text{C} < T_{\text{BLK}} < 70 \text{ }^\circ\text{C}, \quad (4.3.2.7)$$

$$300 \text{ }^\circ\text{C} < T_{\text{source}} < 600 \text{ }^\circ\text{C} \quad (4.3.2.8)$$

We then assume:

$$\varepsilon_{\text{BLK, emitted}} = 0.89 \quad (4.3.2.9)$$

$$\alpha_{\text{BLK, incoming}} = 0.95 \quad (4.3.2.10)$$

The incoming radiative flux:

$$\Phi_{\text{incoming}} = 1.05 \cdot \Phi_{\text{radiative}} + 0.94 \cdot \sigma \cdot (T_{\text{BLK}} + 273)^4 \quad (4.3.2.11)$$

$\Phi_{\text{convective, incoming}}$ may also be calculated, but that parameter is of less use than the C_{tr} , because it is valid only for an object with a certain surface temperature T_{surface}

$$\Phi_{\text{convective}} = C_{\text{tr}} \cdot (T_{\text{air}} - T_{\text{surface}}) \quad (4.3.2.12)$$

Another way to express the incoming radiative flux is the equivalent blackbody temperature of the radiation source, assuming an emissivity of $\varepsilon = 1$ of the source:

$$\begin{aligned}T_{\text{source, blackbody}} &= \\ &= ((\Phi_{\text{radiative}} + 0.89 \cdot \sigma \cdot (T_{\text{BLK, corrected}} + 273)^4) / (0.95 \cdot \sigma))^{1/4} - 273\end{aligned}\quad (4.3.2.13)$$

4.3.3 Warnings in case of sensor overheating

To warn of overheating, we monitor the highest temperature, which is the surface temperature of the BLK sensor. In case of sensors of the FHF series:

$$T_{\text{BLK, corrected}} = T_{\text{BLK}} + 12 \times 10^{-4} \cdot \Phi_{\text{BLK}} \quad (4.3.3.1)$$

$$T_{\text{BLK, corrected}} < 120 \text{ }^\circ\text{C} \quad (4.3.3.2)$$

5 Specifications of BLK – GLD sticker series

5.1 Specifications of BLK – GLD stickers

BLK – GLD stickers can be applied to a heat flux sensor. BLK stickers provide the sensor with a black absorbing surface so that it measures convective and radiative heat flux, in [W/m²]. GLD stickers provide the sensor with a gold reflecting surface so that it measures convective heat flux only. Combining BLK and GLD stickers, applied to two separate heat flux sensors, allows for measurement of radiative heat flux.

Table 5.1.1 *Specifications of BLK – GLD sticker series (continued next page).*

BLK SPECIFICATIONS	
Product type	sticker
Measurand	convective + radiative heat flux
Measurand in SI units	heat flux density in W/m ²
Measurement range	(-2 to 2) × 10 ³ W/m ² (HFP01) (-10 to 10) × 10 ³ W/m ² (FHF05 series)
Measurement function / required programming	$\Phi_{\text{convective+radiative}} = U/S$
Rated temperature range - continuous use	-40 to +150 °C (see also the rated temperature range of the sensors)
Rated temperature range - short intervals	-40 to +260 °C (see also the rated temperature range of the sensors)
Spectral range (UV-VIS-NIR-FIR)	250 to > 10000 × 10 ⁻⁹ m
Absorption over range	> 95 % see the appendix for more information
Carrier material	Polyimide (Kapton®)
Coating material	fully inorganic metal-based
Adhesive	3M™ VHB™ F9460PC acrylic transfer tape
Sticker thickness	0.14 × 10 ⁻³ m
Sticker thermal resistance	10 × 10 ⁻⁴ K/(W/m ²)
Sticker thermal conductivity	1.38 × 10 ⁻¹ W/(m·K)
GLD SPECIFICATIONS	
Product type	sticker
Measurand	convective heat flux
Measurand in SI units	heat flux density in W/m ²
Measurement range	(-2 to 2) × 10 ³ W/m ² (HFP01) (-10 to 10) × 10 ³ W/m ² (FHF05 series)
Measurement function / required programming	$\Phi_{\text{convective}} = U/S$
Rated temperature range - continuous use	-185 to +150 °C (see also the rated temperature range of the sensors)
Rated temperature range - short intervals	-185 to +260 °C (see also the rated temperature range of the sensors)

Table 5.1.1 Specifications of BLK – GLD sticker series (started on previous page, continued next pages).

Spectral range (NIR-FIR)	700 to $> 10000 \times 10^{-9}$ m
Reflection over range	> 95 % see the appendix for more information
Spectral range (VIS)	400 to 700×10^{-9} m
Reflection over range	> 80 % see the appendix for more information
Solar absorption	< 20 %
Carrier material	Polyimide (Kapton®)
Coating material	gold
Adhesive	ARcare® 8026 silicone transfer tape
Sticker thickness	0.05×10^{-3} m
Sticker thermal resistance	3.5×10^{-4} K/(W/m ²)
Sticker thermal conductivity	1.45×10^{-1} W/(m·K)
GENERAL SPECIFICATIONS	
Effect on sensor sensitivity	negligible
Effect on type T sensor (FHF sensors only)	negligible
Additional response time (95 %)	3 s (nominal)
Rated temperature range when applied to sensor	see sensor specifications
Sticker dimensions	
BLK-10X10 / GLD-10X10	$(10 \times 10) \times 10^{-3}$ m
BLK-15X30 / GLD-15X30	$(15 \times 30) \times 10^{-3}$ m
BLK-50X50 / GLD-50X50	$(50 \times 50) \times 10^{-3}$ m
BLK-15X85 / GLD-15X85	$(15 \times 85) \times 10^{-3}$ m
BLK-85X85 / GLD-85X85	$(85 \times 85) \times 10^{-3}$ m
BLK-80 / GLD-80	$\varnothing 80 \times 10^{-3}$ m
Bending radius	see sensor specifications for limiting bending radius
Protection foil	remove before measurement

Table 5.1.1 Specifications of BLK – GLD sticker series (started on previous pages, continued next page).

INSTALLATION AND USE	
Typical conditions of use	in experiments, in measurements in laboratory and industrial environments. Exposed to heat fluxes for periods of several minutes to several years. Sensor connected to user-supplied data acquisition equipment. Regular inspection of the sensor and sticker surface. Continuous monitoring of sensor temperature. No special requirements for immunity, emission, chemical resistance.
Recommended maintenance	see recommendations in this user manual. Sticker surfaces should be kept clean General cleaning: do not use any solvents, gently wipe with optical microfibre cloth and if needed demineralised water.
Application of stickers on sensor	FHF: apply on the side without a dot HFP: apply on the side coloured red sensors are applied so that incoming heat flux on that side produces a positive heat flux signal. see recommendations in this user manual see instruction sheet included with delivery see our instruction video on YouTube, or order sensors with stickers pre-applied at the factory
Installation of sensors	preferably install sensors with BLK and GLD on the same heat sink see recommendations in the sensor manuals see recommendations in this user manual
MEASUREMENT ACCURACY	
Contribution of sensor properties to the uncertainty budget of the measurement	Users should make their own uncertainty evaluation see user manual of the sensor for more information about calibration method and uncertainties
Uncertainty of the measurement	Users should make their own uncertainty evaluation statements about the overall measurement uncertainty can only be made on an individual basis

Table 5.1.1 *Specifications of BLK – GLD sticker series (started on previous pages).*

VERSIONS AND ORDER CODES	
BLK-10X10 / GLD-10X10	to be used with model FHF05-10X10
BLK-15X30 / GLD-15X30	to be used with model FHF05-15X30
BLK-50X50 / GLD-50X50	to be used with model FHF05-50X50
BLK-15X85 / GLD-15X85	to be used with model FHF05-15X85
BLK-85X85 / GLD-85X85	to be used with model FHF05-85X85
BLK-80 / GLD-80	to be used with HFP01 heat flux sensor
OPTIONS	
Pre-applied to the sensor	<p>when opting for pre-application of the sticker to the sensor at the factory, please use the following ordering code:</p> <p>product code sensor with wire / cable length indicated + product code sticker</p> <p>example: HFP01-05-GLD-80 for an HFP01 with 5 metres of cable and a pre-applied gold sticker</p>

5.2 Dimensions of BLK – GLD stickers

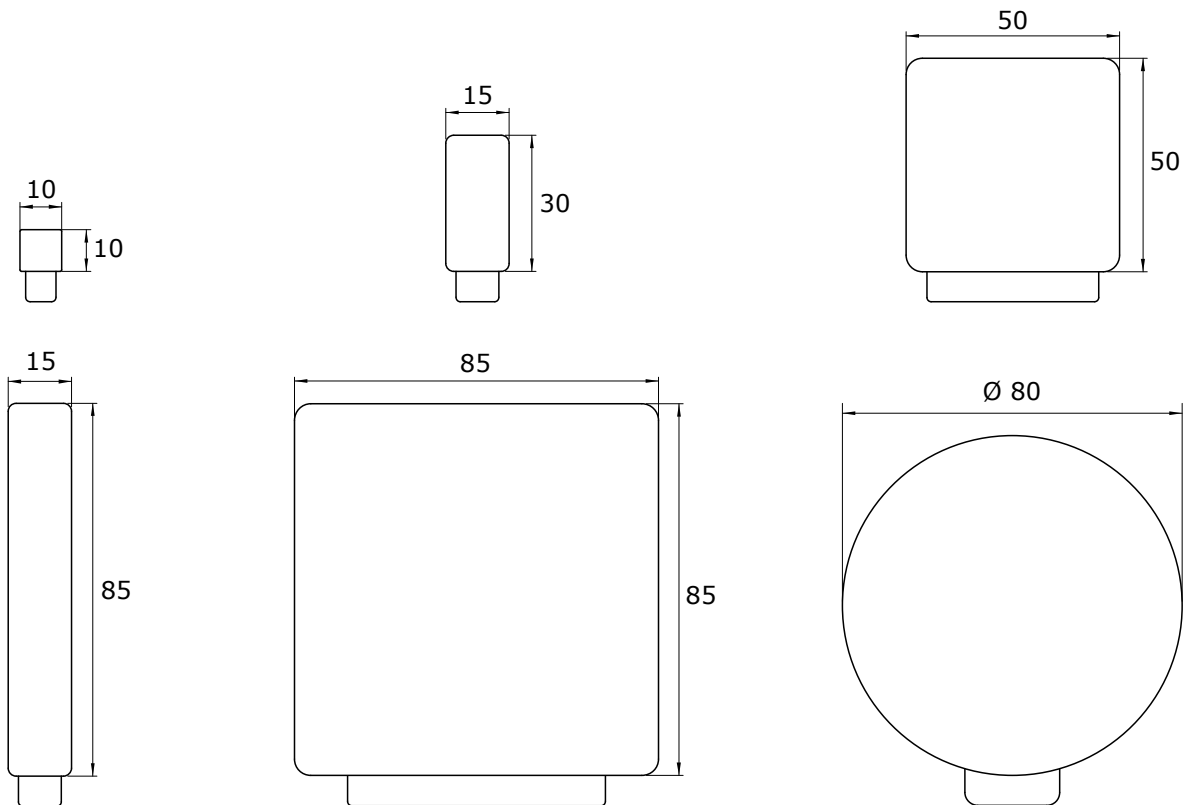

BLK sticker thickness = 0.14 mm

GLD sticker thickness = 0.05 mm

Figure 5.2.1 Dimensions of BLK – GLD stickers; all dimensions in $\times 10^{-3}$ m for both BLK and GLD stickers. Top row from left to right: -10X10, -15X30, -50X50. Bottom row from left to right: -15X85, -85X85 and -80. All BLK stickers have a thickness of 0.14 mm, GLD stickers have a thickness of 0.05 mm.

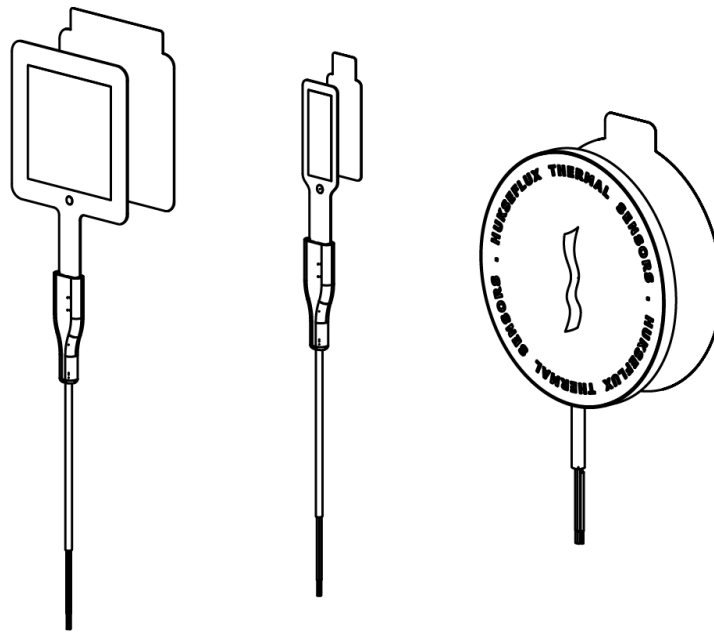

Figure 5.2.2 The dimensions of the BLK – GLD stickers match the dimensions of the corresponding heat flux sensors FHF05 series and HFP01.

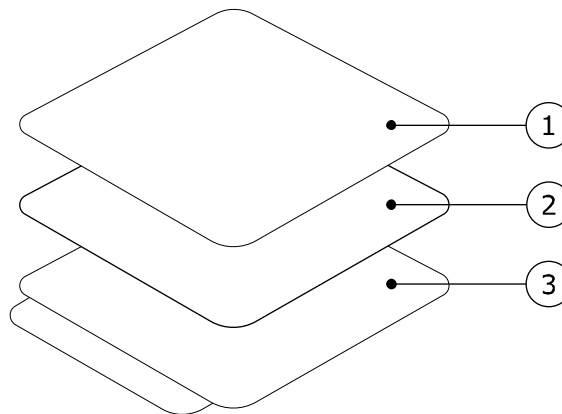

Figure 5.2.3 Layer build-up for the BLK – GLD sticker series. Depicted is BLK/GLD-50X50.

- (1) protective foil – protecting the black absorber or gold reflector (removable)
- (2) BLK / GLD coating on a plastic layer with sticker material
- (3) release liner with peeling tab on the sticker material (removable)

6 Installation of BLK – GLD sticker series

6.1 Application procedure

For the best possible measurement of heat flux sensors with BLK – GLD stickers applied, it is important that the application is done correctly. The stickers must be aligned with the sensor, without leaving scratches, (finger) grease, or inclusion of air pockets.

It is advised to do a quick instrument check of the sensor, before applying the sticker. See the user manual of the sensor for further instructions.

NOTICE

Wear powderless gloves during application.

NOTICE

BLK – GLD stickers are designed for one-time application. Removing stickers after application will make them permanently unsuitable for use.

NOTICE

Do a quick functional check of sensor performance before application of the sticker.

- when applying a BLK black or GLD gold sticker to FHF05(SC), please note it should be applied to the side of the heat flux sensor where the dot on the foil is NOT visible.
- when applying a BLK black or GLD gold sticker to HFP01, please note it should be applied to the side of the heat flux sensor which is coloured red.

Table 6.1.1 Application procedure for BLK – GLD stickers (continued next page).

- 1 Place the sensor on a stable surface as shown on the right. Make sure the correct side is facing upward. Before applying the sticker, clean the sensor surface using an alcohol (IPA) wipe provided with the sticker.

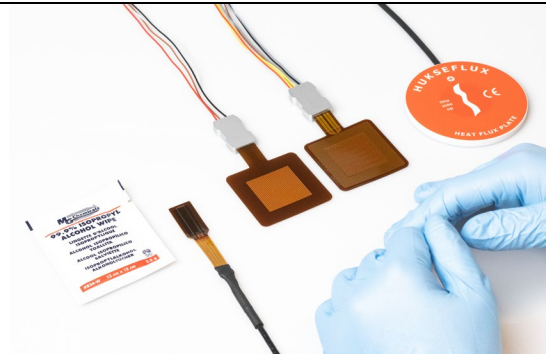

- 2 Partially peel and cut away the release liner (approximately 1 cm) so that the sticker material (glue layer) is exposed. Do not remove the release liner completely.



- 3 Position the sticker onto the sensor surface without applying force to the top part of the sticker (now covered by a protective foil) of which the release liner has been removed. If you apply pressure it will be permanently mounted. If the sticker is not aligned properly with the sensor, carefully move it around until it aligns.

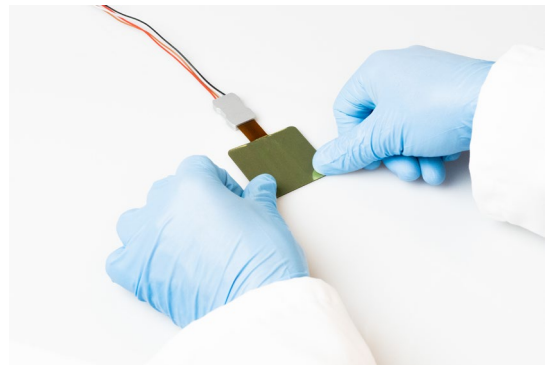

- 4 Once the sensor and sticker are well aligned, mount the top part of the sticker of which the sticker material has been removed by applying pressure. Make sure no air bubbles are enclosed. Do not remove the sticker after mounting it, as it might damage the coating of the sticker.

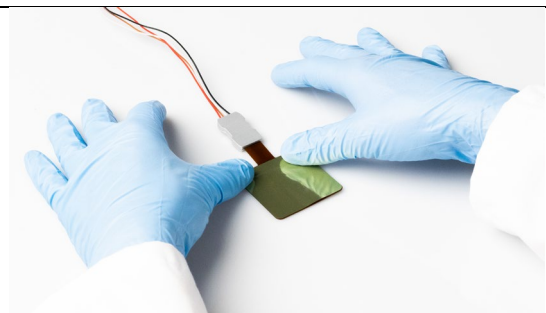
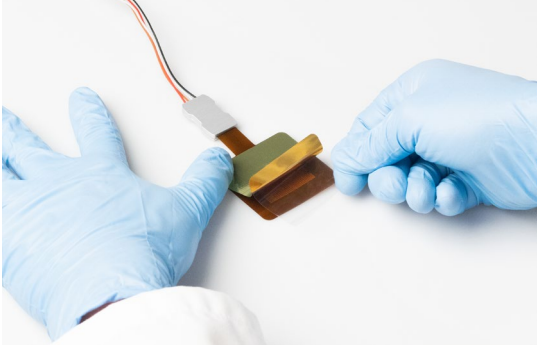
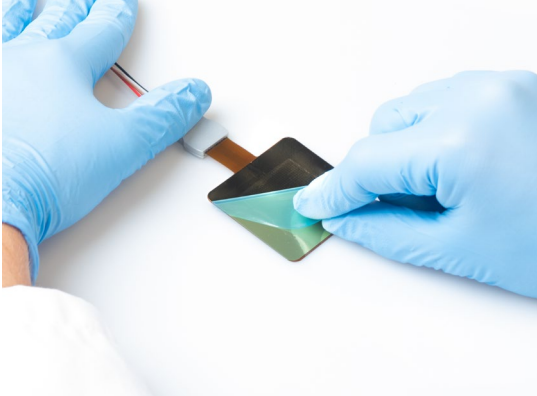

Table 6.1.1 Application procedure for BLK – GLD stickers (started on previous page).

<p>5 Slowly peel off the remaining release liner while simultaneously applying the rest of the sticker on the sensor. Again, avoid including air pockets.</p>	
<p>6 Remove the protective foil from the top of the black absorber or gold reflector before measuring. Handle with care once the protective foil is removed.</p>	

6.2 Site selection and sensor installation

Table 6.2.1 Recommendations for installation of sensors with BLK – GLD stickers (continued on next page).

<p>Location</p>	<p>choose a location that is representative of the process that is analysed avoid direct exposure to the sun</p>
<p>Positioning</p>	<p>when using multiple sensors with BLK and GLD stickers, place them side by side on the same heat sink (a metal plate) so that they have approximately the same temperature</p>
<p>Surface cleaning and levelling</p>	<p>create a clean and smooth surface before mounting the sensor</p>
<p>Mounting: orientation</p>	<p>when mounting a BLK or GLD sticker on an FHF05 or HFP01 sensor, keep the directional sensitivity in mind orient the sensor surface with sticker away from the object on which it is mounted</p>
<p>Mounting: avoiding strain on sensor cable or wires</p>	<p>during installation as well as operation, the user should provide proper strain relief of the sensor cable/wires so that they are not exposed to significant force first, install the cable/wires including strain relief and after that install the sensor</p>

Table 6.2.1 Recommendations for installation of sensors with BLK – GLD stickers (started on previous page).

Mounting: curved surfaces	when mounting sensors on curved surfaces, apply BLK – GLD stickers before mounting the sensor. See the user manual of the sensor for its rated bending radius
Short term installation	<p>avoid any air gaps between the sensor and the surface. Air thermal conductivity is in the 0.02 W/(m·K) range, while a common glue has a thermal conductivity around 0.2 W/(m·K). An air gap of 0.1×10^{-3} m increases the effective thermal resistance of the sensor by 200 %</p> <p>to avoid air gaps, we recommend thermal paste or glycerol for short-term installation. When mounting on curved surfaces, glycerol is not recommended as it will leak out</p> <p>if users choose to use tape to attach the sensor on the surface of the object under study, then tape only over the passive guard area (the area without thermopile traces), see Figure 6.2.1</p> <p>Provide strain relief to the sensor cable</p> <p>usually, the cables are provided with an additional strain relief, for example using a cable tie mount as in Figure 6.2.1</p>
Permanent installation	<p>for long-term installation, fill up the space between sensor and object with silicone construction sealant, silicone glue or silicone adhesive that can be bought in construction depots</p> <p>the use of thermal paste for permanent installation is discouraged because it will dry out over time. Silicone glue is more stable and reliable</p>
Electrical connection	<p>when measuring incoming radiation, connect the sensor as indicated in the user manual of the sensor. Incoming radiation will then give a positive sensor signal</p> <p>for measurements of outgoing radiation, switch the [+] and [-] wires of the sensor to change its polarity. Outgoing radiation will then give a positive sensor signal</p>

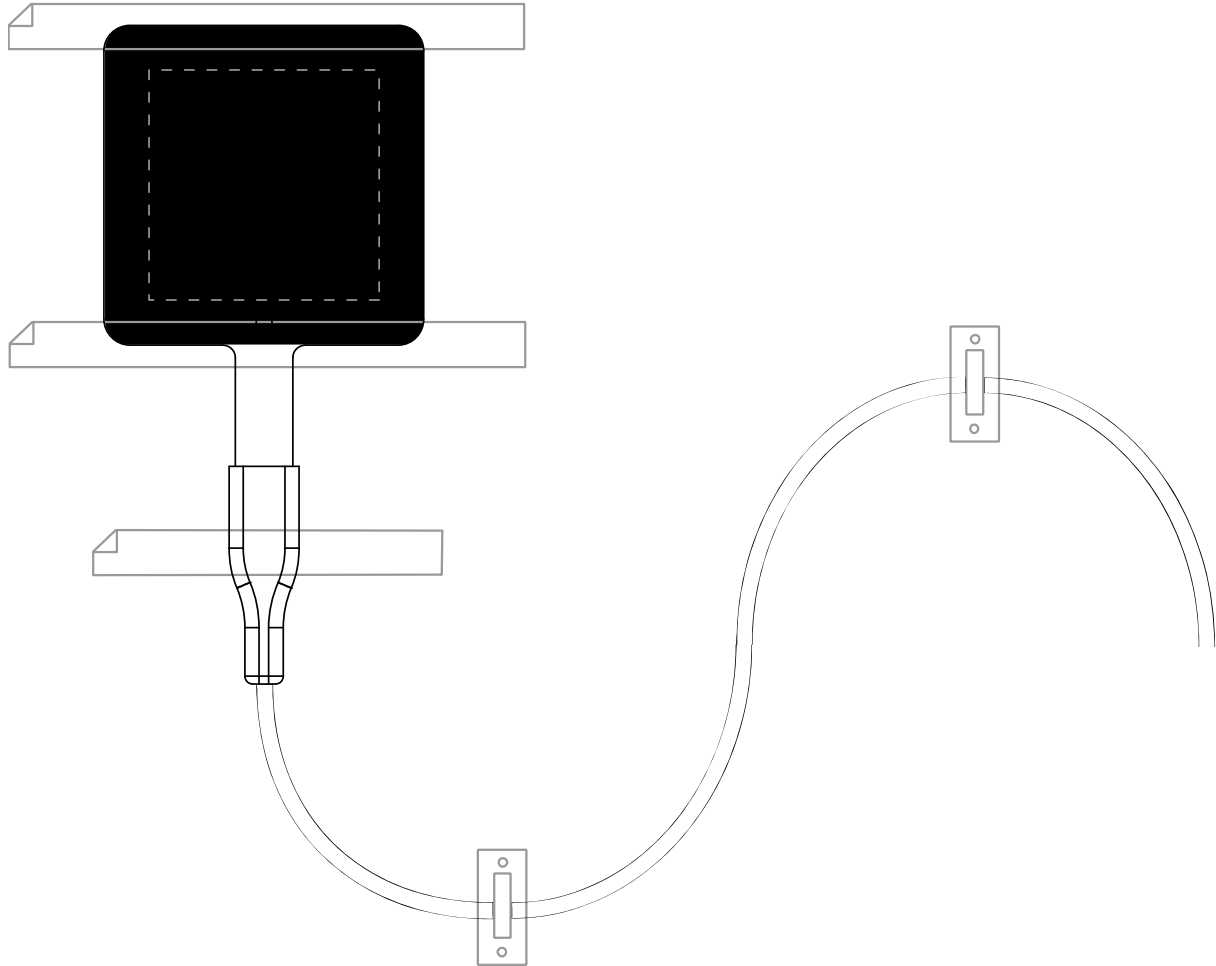

Figure 6.2.1 *Installation of model FHF05-50X50 with BLK sticker using tape to attach the sensor and FHF05-50X50 cable connection block serving as strain relief. Extra strain relief on the wires may be provided using cable tie mounts equipped with double-sided adhesive tape. As indicated in the sensor manual, tapes for mounting of the sensor should only cover the passive guard area and not over the sensing area (the latter indicated by a dashed line).*

7 Maintenance and trouble shooting

7.1 Recommended maintenance and quality assurance

Hukseflux heat flux sensors with stickers perform reliably when kept clean. Unreliable sensor output can be detected by scientific judgement, for example, by looking for unreasonably large or small measured values. The preferred way to ensure a reliable sensor output is to regularly inspect surfaces critically and review the measured data.

Table 7.1.1 *Recommended maintenance of BLK – GLD stickers.*

MINIMUM RECOMMENDED STICKER MAINTENANCE			
	INTERVAL	SUBJECT	ACTION
1	as required for the application	cleaning	<p>Clean the stickers so that they keep their required reflective and absorptive properties. Especially the GLD stickers must be treated with care, the gold layer thickness is very limited, and it may easily be rubbed away by friction.</p> <p>General cleaning: do not use any solvents, gently wipe with optical microfibre cloth and if needed demineralised water.</p> <p>GLD stickers only: in case normal cleaning does not work use alcohol or acetone on a soft cloth.</p> <p>BLK stickers: do not use any solvents.</p> <p>In case of damage, users may remove stickers and replace them by a new sticker.</p> <p>Sensors may also be sent to Hukseflux to apply a new sticker.</p>

NOTICE

Treat BLK and GLD stickers with care. Avoid abrasive action. Clean gently with soft cloth and if needed with demi-water. The gold layer of the GLD sticker is extremely thin and may easily be rubbed off.

For sensor maintenance: consult the sensor manual. Here are some general recommendations.

Table 7.1.2 *General recommended maintenance of heat flux sensors. If possible, the data analysis is done on a daily basis.*

GENERAL: MINIMUM RECOMMENDED HEAT FLUX SENSOR MAINTENANCE			
	INTERVAL	SUBJECT	ACTION
1	1 week	data analysis	compare measured data to the maximum possible or maximum expected heater power, to other measurements from other redundant instruments and to data previously measured under identical circumstances. Look for any patterns and events that deviate from what is normal or expected. Set acceptance intervals and compare measured data to these acceptance intervals.
2	6 months	inspection	inspect sensor for wear, cable and wire condition, clamping of conductors at the data acquisition, inspect sensor mounting, inspect the location of installation Look for seasonal patterns in measurement data
3	2 years	recalibration	recalibration by comparison to a calibration standard instrument in the field, see following paragraphs. recalibration by the sensor manufacturer
4	2 years	lifetime assessment	judge if the instrument will be reliable for another 2 years, or if it should be replaced

7.2 Trouble shooting

Table 7.2.1 *Trouble shooting for heat flux sensors with BLK – GLD stickers.*

General	<p>Inspect the quality of application / installation.</p> <p>Inspect the sticker surface for any damage or stains like grease or dirt.</p> <p>Inspect if there are any air pockets between the sticker, sensor and surface.</p>
Grease or dirt on BLK surface	<p>Gently clean with a soft cloth, like an anti-static or microfiber cloth, and demineralised water. Avoid IPA or acetone as it will remove the black coating.</p> <p>Wear powderless gloves during cleaning.</p>
Grease or dirt on GLD surface	<p>Gently clean with a soft cloth, like an anti-static or microfiber cloth, and IPA or acetone. Avoid touching the sticker surface with anything other than a soft cloth as it highly prone to scratching. Wear powderless gloves during cleaning.</p>
The sensor signal has the wrong polarity	<p>Check if the sticker is applied to the correct side of the sensor.</p> <p>Do not remove stickers that are already installed.</p> <p>In general polarity issues may be solved</p> <ul style="list-style-type: none"> - in post-processing of data (reverse the sign in the program) - disconnection the sensor from its mounting and reversing its position (not possible if a sticker has already been applied to the sensor surface) - by reversal of the connection of [+] and [-] heat flux sensor output wires at the data acquisition.
Issues with sensor signal	<p>See sensor manuals for help on trouble shooting with the sensor signal. A good start is to measure the electrical resistance of the sensor. Close to 1 Ohm indicates a short-circuit, more than 1 MΩ indicates a wire or sensor failure.</p>

7.3 Calibration and on-site checks

The recommended calibration interval of heat flux sensors is 2 years. Recalibration of field heat flux sensors with stickers is ideally done by the sensor manufacturer.

On-site (field) calibration is possible by comparing it to a calibration reference sensor, which is usually mounted side by side or on top of the field sensor.

Hukseflux's main recommendations for on-site calibrations are:

- 1) to compare to a calibration reference of the same brand and type as the sensor that is used
- 2) to connect both to the same electronics, so that electronics errors (also offsets) are eliminated
- 3) to mount all sensors on the same platform, so that they have the same body temperature
- 4) typical duration of test: > 24 h
- 5) typical heat fluxes used for comparison: > 600 W/m²
- 6) to correct deviations of more than ± 20 %. Lower deviations may be interpreted as acceptable and may not necessarily lead to a revised sensitivity

Users may also design their own calibration experiment, for example using a well-characterised foil heater.

8 Appendices

8.1 Reflection versus wavelength and source temperature

Figures 8.1.1 and 8.1.2 show the reflection of the BLK and GLD stickers as a function of wavelength of the incoming radiation. Upon request, the data from these graphs are also available in CSV format.

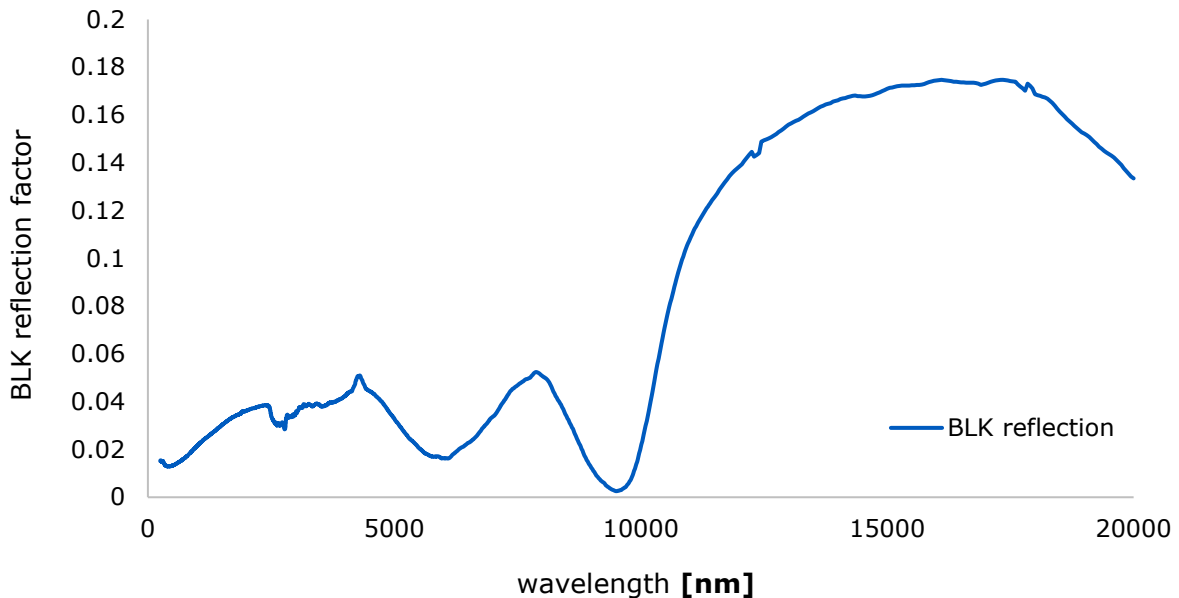

Figure 8.1.1 Reflection factor of BLK sticker as a function of wavelength of the incoming radiation.

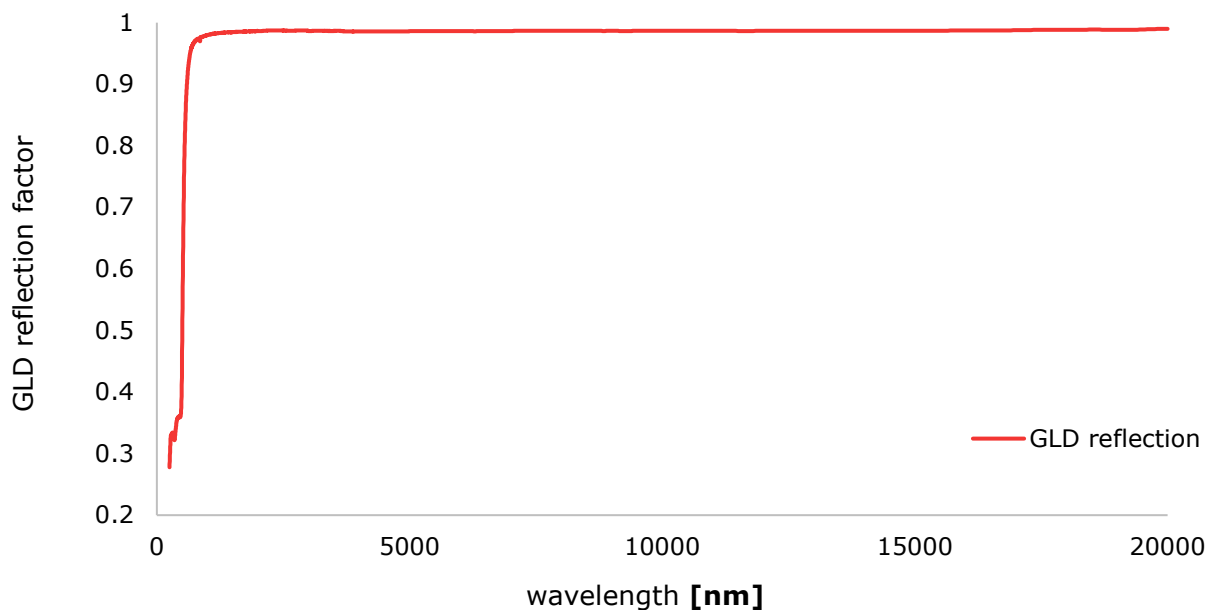

Figure 8.1.2 Reflection factor of GLD sticker as a function of wavelength of the incoming radiation.

Usually, the spectral composition of the source is not known exactly. If the source can be reasonably described as a blackbody source of a certain temperature T , an average reflectance factor can be calculated by integrating the reflectance of the sticker with the blackbody spectrum. This way, the formulas of section 2.3 can be used.

Figures 8.1.3 and 8.1.4 and Table 8.1.1 show the average reflection factor for the BLK and GLD sticker for blackbody sources of different temperatures.

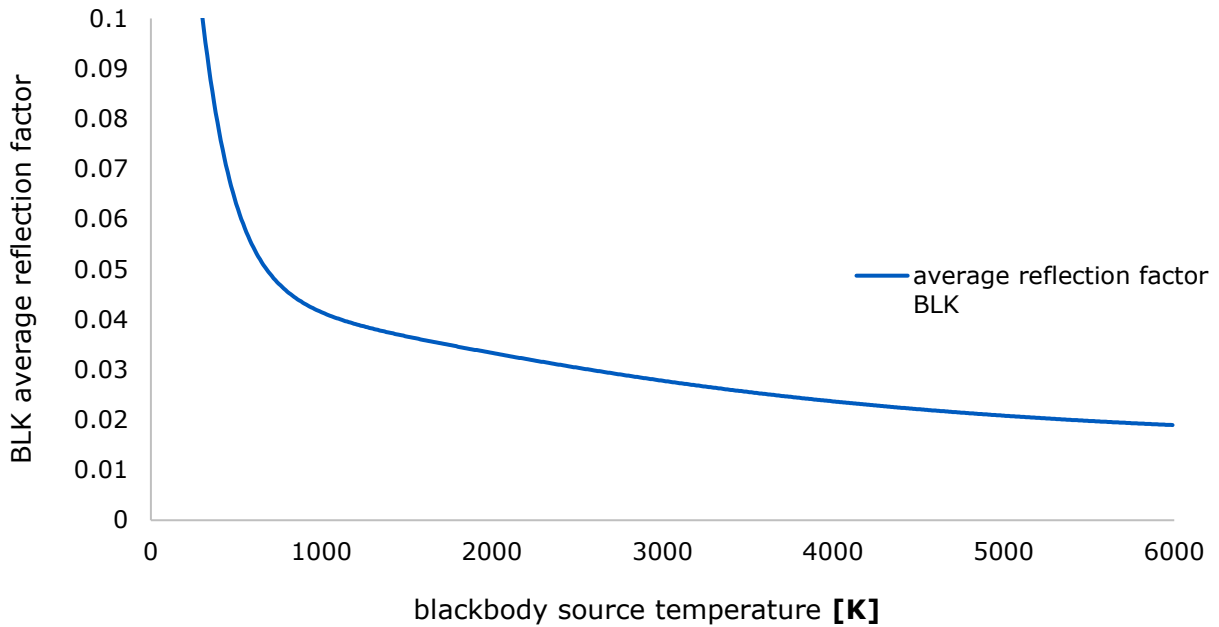

Figure 8.1.3 Average reflection factor of BLK sticker when measuring radiation from blackbody sources of different temperatures.

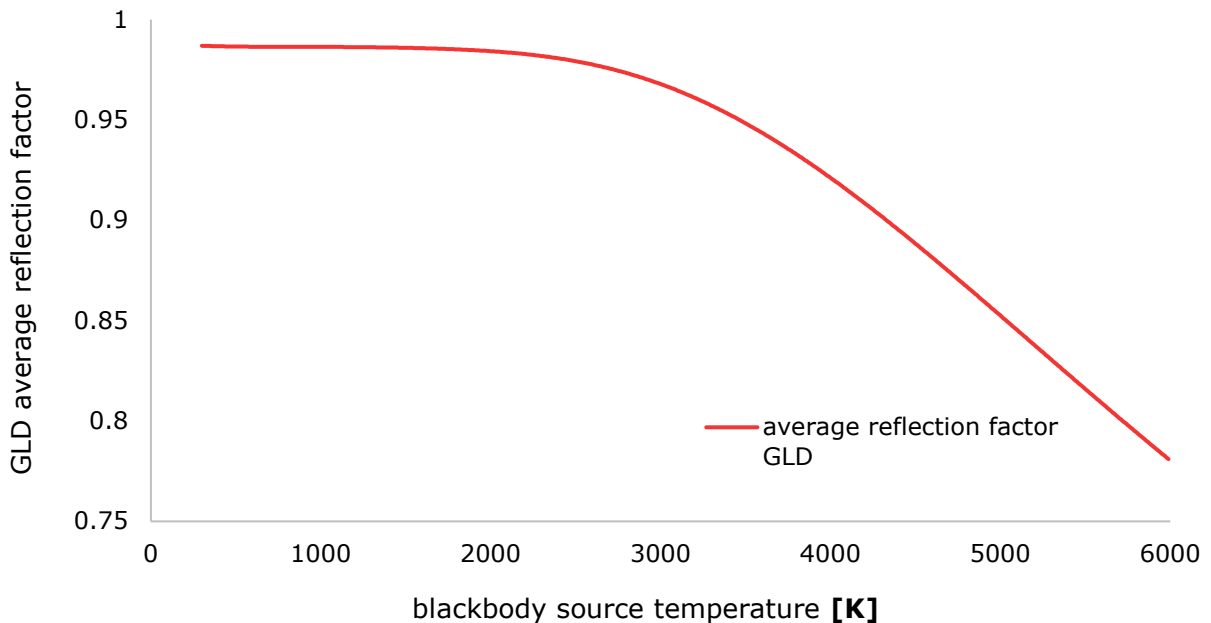

Figure 8.1.4 Average reflection factor of GLD sticker when measuring radiation from blackbody sources of different temperatures.

Table 8.1.1 Average reflection factors of BLK and GLD for various blackbody source temperatures.

blackbody source temperature [°C]	average reflection factor BLK	average reflection factor GLD
-40	0.13	0.99
-30	0.12	0.99
-20	0.12	0.99
-10	0.12	0.99
0	0.12	0.99
10	0.11	0.99
20	0.11	0.99
30	0.11	0.99
40	0.11	0.99
50	0.10	0.99
60	0.10	0.99
70	0.10	0.99
80	0.10	0.99
90	0.09	0.99
100	0.09	0.99
150	0.08	0.99
200	0.07	0.99
250	0.07	0.99
300	0.06	0.99
350	0.06	0.99
400	0.05	0.99
450	0.05	0.99
500	0.05	0.99
600	0.05	0.99
700	0.04	0.99
800	0.04	0.99
900	0.04	0.99
1000	0.04	0.99
1500	0.04	0.99
2000	0.03	0.98
2500	0.03	0.97
3000	0.03	0.96
3500	0.02	0.93
4000	0.02	0.90
4500	0.02	0.87
5000	0.02	0.83
5500	0.02	0.80

8.2 EU declaration of conformity



We, Hukseflux Thermal Sensors B.V.,
Delftechpark 31, 2628 XJ, Delft,
The Netherlands

hereby declare under our sole responsibility that:

Product model BLK GLD sticker series, all models*
Product type Stickers

conform with the following directive(s):

2011/65/EU, EU 2015/863 The Restriction of Hazardous Substances Directive

This conformity is declared using the relevant sections and requirements of the following standards:

Hazardous substances EU RoHS2 (2011/65/EU) and
EU 2015/863 amendment known as RoHS 3



Eric HOEKSEMA
Director
Delft
June 30, 2022

* NOTE: these are passive components. When implemented in a system, this system should be subjected to independent conformity assessment.

