

USER MANUAL **FHF04**

Foil heat flux sensor with thermal spreaders, flexible,
50 x 50 mm, with temperature sensor

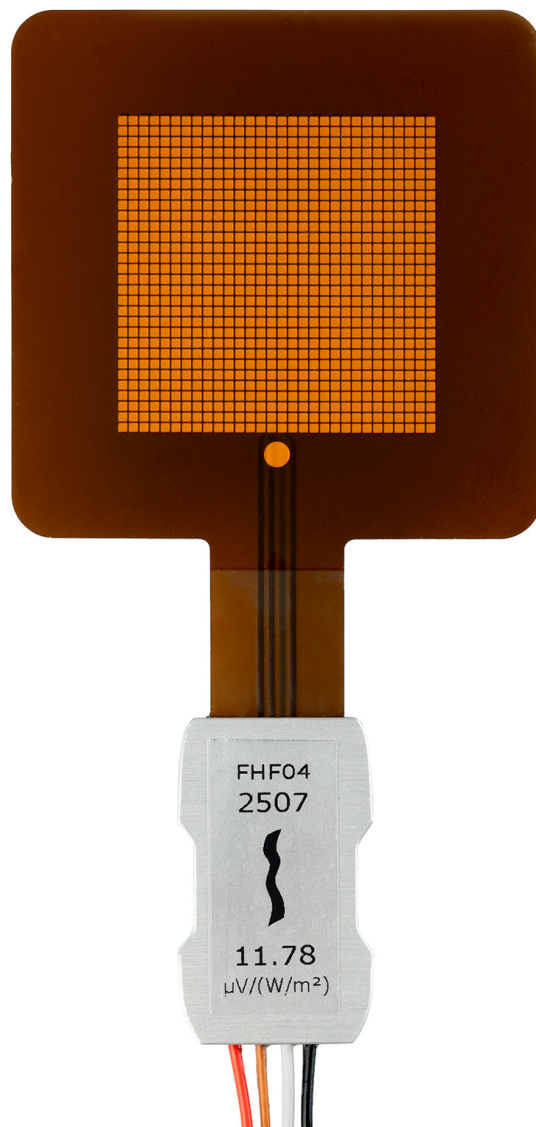

Cautionary statements

Cautionary statements are subdivided into four categories: danger, warning, caution and notice according to the severity of the risk.

 DANGER
Failure to comply with a danger statement will lead to death or serious physical injuries.

 WARNING
Failure to comply with a warning statement may lead to risk of death or serious physical injuries.

 CAUTION
Failure to comply with a caution statement may lead to risk of minor or moderate physical injuries.

NOTICE
Failure to comply with a notice may lead to damage to equipment or may compromise reliable operation of the instrument.

Contents

Cautionary statements	2
Contents	3
List of symbols	4
Introduction	5
1 Ordering and checking at delivery	8
1.1 Ordering FHF04	8
1.2 Included items	8
1.3 Quick instrument check	9
2 Instrument principle and theory	10
3 Specifications of FHF04	13
3.1 Specifications of FHF04	13
3.2 Dimensions of FHF04	16
4 Standards and recommended practices for use	17
4.1 Heat flux measurement in industry	17
5 Installation of FHF04	18
5.1 Site selection and installation	18
5.2 Installation on curved surfaces	20
5.3 Electrical connection	21
5.4 Requirements for data acquisition / amplification	24
6 Maintenance and trouble shooting	25
6.1 Recommended maintenance and quality assurance	25
6.2 Trouble shooting	26
6.3 Calibration and checks in the field	27
7 Appendices	29
7.1 Appendix on wire extension	29
7.2 Appendix on installation of FHF04 sensor foil	30
7.3 Appendix on using FHF04 with BLK – GLD sticker series	33
7.4 Appendix on standards for calibration	34
7.5 Appendix on calibration hierarchy	34
7.6 Appendix on correction for temperature dependence	35
7.7 Appendix on measurement range for different temperatures	36
7.8 Appendix on temperature measurement accuracy	37
7.9 EU declaration of conformity	38

List of symbols

Quantities

Heat flux
Voltage output
Sensitivity
Temperature
Thermal resistance per unit area

Symbol

Φ
U
S
T
 $R_{\text{thermal,A}}$

Unit

W/m²
V
V/(W/m²)
°C
K/(W/m²)

subscripts

property of heatsink
maximum value, specification limit

heatsink
maximum

Introduction

FHF04 is the latest standard model for general-purpose heat flux measurement. Significantly thinner and more flexible, FHF04 replaces earlier models FHF01 and FHF02. FHF04 is very versatile: it has an integrated temperature sensor and thermal spreaders to reduce thermal conductivity dependence. It is applicable over a temperature range from -70 to $+120$ °C. FHF04 measures heat flux from conduction, radiation and convection. Optionally, black BLK and gold GLD stickers are available to separately determine heat transport by radiation and convection.

FHF04 measures heat flux through the object in which it is incorporated or on which it is mounted, in W/m^2 . The sensor in FHF04 is a thermopile. This thermopile measures the temperature difference across FHF04's flexible body. A type T thermocouple is integrated as well. The thermopile and thermocouple are passive sensors; they do not require power.

Multiple small thermal spreaders, which form a conductive layer covering the sensor, help reduce the thermal conductivity dependence of the measurement. With its incorporated spreaders, the sensitivity of FHF04 is independent of its environment. Many competing sensors do not have thermal spreaders. The passive guard area around the sensor reduces measurement errors due to edge effects and is also used for mounting.

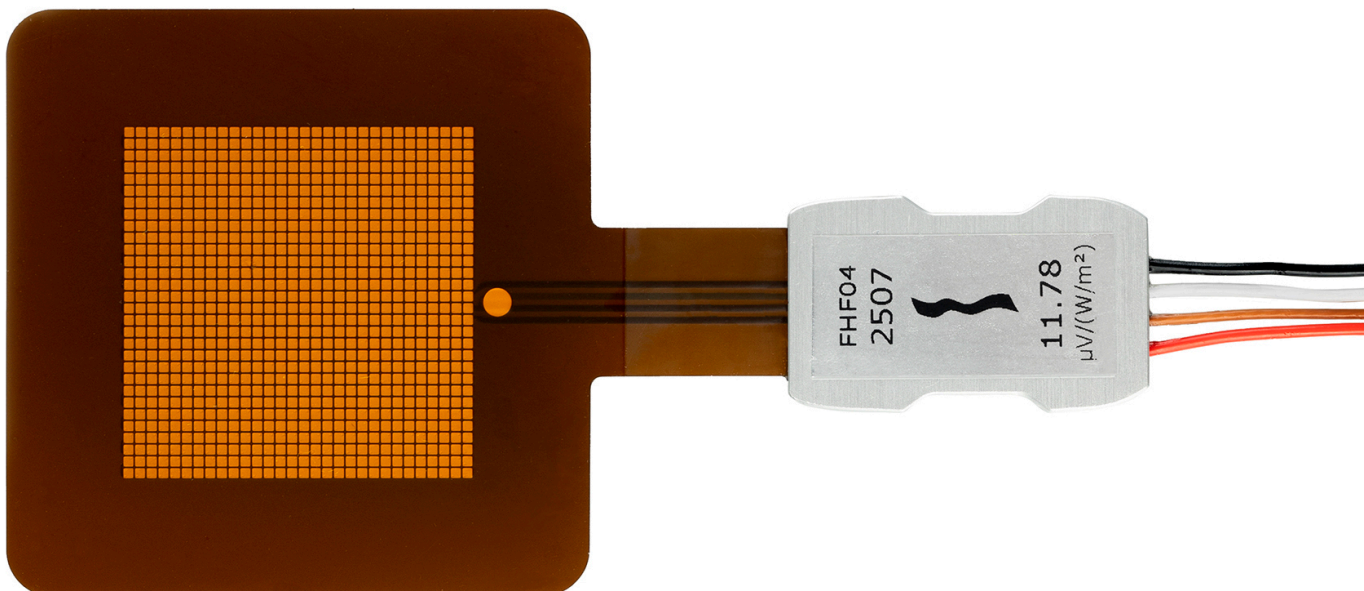

Figure 0.1 FHF04 foil heat flux sensor with thermal spreaders: thin, flexible and versatile

Using FHF04 is easy. It can be connected directly to commonly used data logging systems. The heat flux in W/m^2 is calculated by dividing the FHF04 output, a small voltage, by the sensitivity. The sensitivity is provided with FHF04 on its product certificate.

FHF04 foil heat flux sensor has unique features and benefits:

- flexible (bending radius $\geq 7.5 \times 10^{-3}$ m)
- low thermal resistance
- wide temperature range
- fast response time
- large guard area
- integrated type T thermocouple
- robustness, including wiring and metal connection block, may be used as strain relief between sensor and wires
- IP protection class: IP67 (essential for outdoor application)
- integrated thermal spreaders for low thermal conductivity dependence

Equipped with a metal connection block, which may serve as strain relief, and with potted protective covers on both sides so that moisture does not penetrate, FHF04 has proven to be very robust and stable.



Figure 0.2 FHF04 foil heat flux sensor being installed to measure heat flux on a pipe

FHF04 calibration is traceable to international standards. The factory calibration method follows the recommended practice of ASTM C1130 - 17. When used under conditions that differ from the calibration reference conditions, the FHF04 sensitivity to heat flux may be different than stated on its certificate. See Chapter 2 in this manual for suggested solutions.

Would you like to study energy transport / heat flux in detail? Hukseflux helps taking this measurement to the next level: order FHF04 with radiation-absorbing black and radiation-reflecting gold stickers. You can then measure convective + radiative flux with one, and convective flux only with the other. Subtract the 2 measurements and you have radiative

flux. They can be applied to the sensor by the user or ordered pre-applied at the factory; see the BLK – GLD sticker series user manual and installation video for instructions.

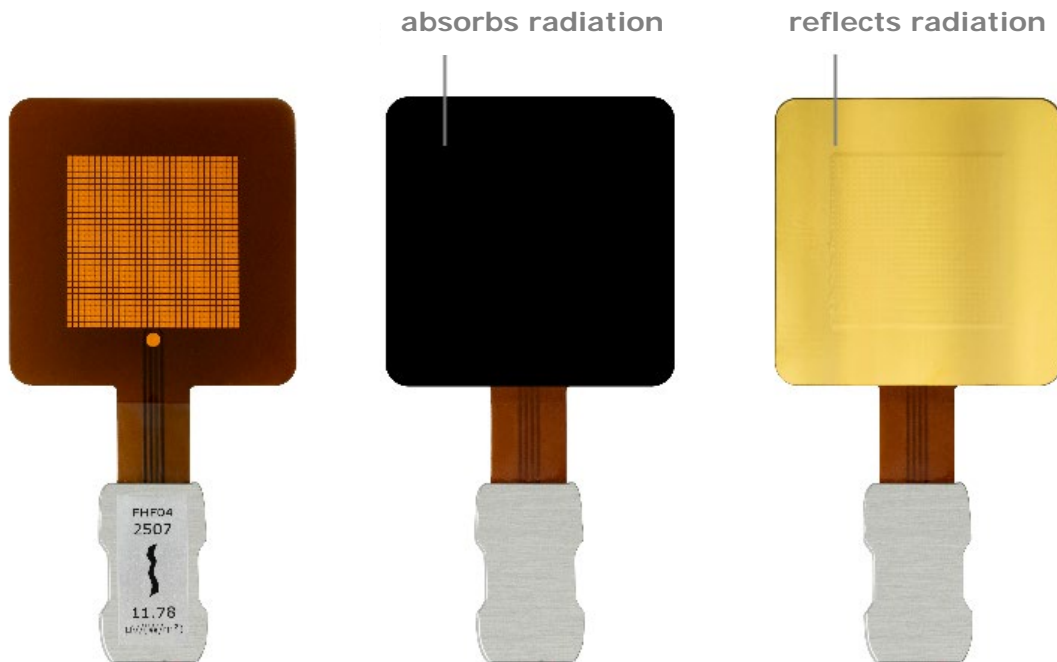

Figure 0.3 FHF04 heat flux sensor: with BLK-5050 and GLD-5050 stickers

See also:

- model **FHF04SC** for a self-calibrating version of FHF04
- model **FHF03**, our most economical foil heat flux sensor
- model **HFP01** for increased sensitivity (also consider putting two or more FHF04s in series)
- **BLK - GLD sticker series** to separate radiative and convective heat fluxes
- Hukseflux offers a complete range of **heat flux sensors** with the highest quality for any budget

1 Ordering and checking at delivery

1.1 Ordering FHF04

The standard configuration of FHF04 is with 2 metres of wire.

Common options are:

- with 5 metres wire length
- without wiring, without metal connection block
- with LI19 hand-held read-out unit / datalogger; NOTE: LI19 measures heat flux only, not temperature
- BLK-5050 black sticker (to measure radiative as well as convective heat flux)
- GLD-5050 gold sticker (to measure convective heat flux only)
- BLK - GLD sticker series can also be ordered pre-applied at the factory

1.2 Included items

Arriving at the customer, the delivery should include:

- heat flux sensor FHF04 with wires of the length as ordered
- product certificate matching the instrument serial number

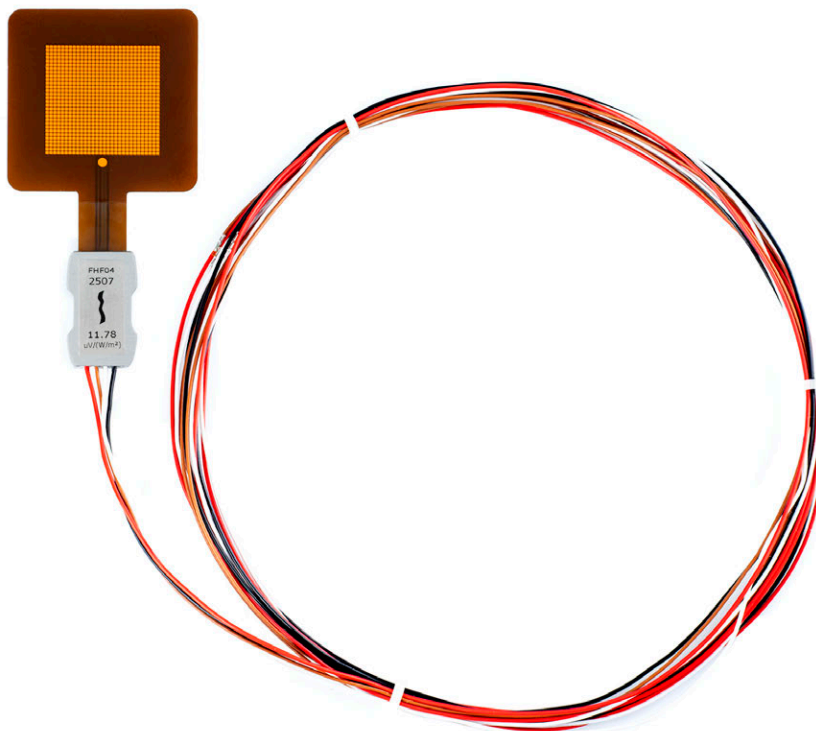

Figure 1.2.1 FHF04's serial number and sensitivity are visible on the metal connection block. FHF04 is delivered with bundled wiring.

1.3 Quick instrument check

A quick test of the instrument can be done by connecting it to a multimeter.

1. Check the sensor serial number and sensitivity on the sticker on the metal connection block against the product certificate provided with the sensor.
2. Inspect the instrument for any damage.
3. Check the electrical resistance of the sensor between the red [+] and black [-] wires. Use a multimeter at the 1k Ω range. Measure the sensor resistance first with one polarity, then reverse the polarity. Take the average value. The typical resistance of the wiring is 0.1 Ω /m. Typical resistance should be the nominal sensor resistance of 200 Ω plus 0.2 Ω for the total resistance of two wires for each metre (back and forth). Infinite resistance indicates a broken circuit; zero or a lower than 1 Ω resistance indicates a short circuit.
4. Check the electrical resistance of the thermocouple between the brown [+] and white [-] wires. Use a multimeter at the 100 Ω range. Measure the thermocouple resistance first with one polarity, then reverse the polarity. Take the average value. The typical resistance of the copper wiring is 0.1 Ω /m, for the constantan wiring this is 2.5 Ω /m. Typical resistance should be the nominal thermocouple resistance of 2.5 Ω plus 2.6 Ω for the total resistance of the two wires of each metre (back and forth). Infinite resistance indicates a broken circuit; zero or a lower than 1 Ω resistance indicates a short circuit.
5. Check if the sensor reacts to heat: put the multimeter at its most sensitive range of DC voltage measurement, typically the 100 x 10⁻³ VDC range or lower. Expose the sensor to heat. Exposing the back side (the side without the dot) to heat should generate a positive signal between the red [+] and black [-] wires. Doing the same at the front side (the side with the dot), reverses the sign of the output.

2 Instrument principle and theory

FHF04's scientific name is heat flux sensor. A heat flux sensor measures the heat flux density through the sensor itself. This quantity, expressed in W/m^2 , is usually called "heat flux".

FHF04 users typically assume that the measured heat flux is representative of the undisturbed heat flux at the location of the sensor. Users may also apply corrections based on scientific judgement.

The sensor in FHF04 is a thermopile. This thermopile measures the temperature difference across the polyimide body of FHF04. Working completely passive, the thermopile generates a small voltage that is a linear function of this temperature difference. The heat flux is proportional to the same temperature difference divided by the effective thermal conductivity of the heat flux sensor body.

Using FHF04 is easy. For readout the user only needs an accurate voltmeter that works in the millivolt range. To convert the measured voltage, U , to a heat flux Φ , the voltage must be divided by the sensitivity S , a constant that is supplied with each individual sensor.

$$\Phi = U/S \quad \text{(Formula 2.1.1)}$$

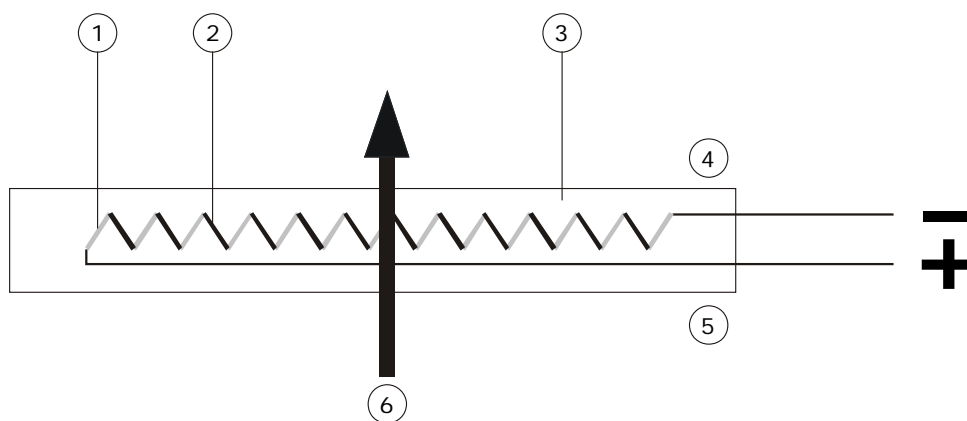

Figure 2.1 The general working principle of a heat flux sensor. The sensor inside FHF04 is a thermopile. A thermopile consists of a number of thermocouples, each consisting of two metal alloys (marked 1 and 2), electrically connected in series. A single thermocouple generates an output voltage that is proportional to the temperature difference between its hot- and cold joints. Putting thermocouples in series amplifies the signal. In a heat flux sensor, the hot- and cold joints are located at the opposite sensor surfaces (4 and 5). In steady state, the heat flux (6) is a linear function of the temperature difference across the sensor and the average thermal conductivity of the sensor body (3). The thermopile generates a voltage output proportional to the heat flux through the sensor. The exact sensitivity of the sensor is determined at the manufacturer by calibration, and can be found on the product certificate that is supplied with each sensor.



Figure 2.2 Heat flux from the back side to the front side generates a positive voltage output signal. The dot on the foil indicates the front side.

FHF04 is designed such that heat flux from the back side to the front side generates a positive voltage output signal. The dot on the foil indicates the front side.

Unique features of the FHF04 include flexibility (bending radius $\geq 7.5 \times 10^{-3}$ m), low thermal resistance, a wide temperature range, a fast response time, IP67 protection class rating (essential for outdoor application), and the inclusion of thermal spreaders to reduce thermal conductivity dependence.

FHF04 is calibrated under the following reference conditions:

- conductive heat flux (as opposed to radiative or convective heat flux)
- homogeneous heat flux across the sensor and guard surface
- room temperature
- heat flux in the order of 600 W/m²
- mounted on aluminium heat sink

FHF04 has been calibrated using a well-conducting metal heat sink, representing a typical industrial application, at 20 °C and exposing it to a conductive heat flux. When used under conditions that differ from the calibration reference conditions, for example at extremely high or low temperatures, or exposed to radiative flux, the FHF04 sensitivity to heat flux may be different than stated on the certificate. In such cases, the user may choose:

- not to use the sensitivity and only perform relative measurements / monitor changes
- reproduce the calibration conditions by mounting the sensor on or between metal foils
- design a dedicated calibration experiment, for example using a foil heater which generates a known heat flux
- apply our BLK-5050 sticker to the sensor surface to absorb radiation
- apply our GLD-5050 sticker to the sensor surface to reflect radiation

The user should analyse his own experiment and make his own uncertainty evaluation. The FHF04 rated temperature range for continuous use is -70 to +120 °C, for short intervals, a peak temperature of +150 °C is allowed. Prolonged exposure to temperatures near +150 °C can accelerate the aging process.

3 Specifications of FHF04

3.1 Specifications of FHF04

FHF04 measures the heat flux density through the surface of the sensor. This quantity, expressed in W/m^2 , is called heat flux. Working completely passive, using a thermopile sensor, FHF04 generates a small output voltage proportional to this flux. It can only be used in combination with a suitable measurement system.

Table 3.1.1 *Specifications of FHF04 (continued on next pages)*

FHF04 SPECIFICATIONS	
Sensor type	foil heat flux sensor
Sensor type according to ASTM	heat flow sensor or heat flux transducer
Measurand	heat flux
Measurand in SI units	heat flux density in W/m^2
Measurement range	$(-10 \text{ to } +10) \times 10^3 \text{ W/m}^2$ at heat sink temperature $20 \text{ }^\circ\text{C}$ see appendix for detailed calculations
Sensitivity range	$9 - 13 \times 10^{-6} \text{ V}/(\text{W/m}^2)$
Sensitivity (nominal)	$11 \times 10^{-6} \text{ V}/(\text{W/m}^2)$
Directional sensitivity	heat flux from the back side to the front side (side with the dot) generates a positive voltage output signal
Increased sensitivity	multiple sensors may be put electrically in series. The resulting sensitivity is the sum of the sensitivities of the individual sensors
Expected voltage output	$(-100 \text{ to } +100) \times 10^{-3} \text{ V}$ turning the sensor over from one side to the other will lead to a reversal of the sensor voltage output
Measurement function / required programming	$\Phi = U/S$
Required readout	1 differential voltage channel or 1 single ended voltage channel, input resistance $> 10^6 \Omega$
Optional readout	1 temperature channel
Rated load on wires	$\leq 1.6 \text{ kg}$
Rated bending radius	$\geq 7.5 \times 10^{-3} \text{ m}$
Rated temperature range, continuous use	$-70 \text{ to } +120 \text{ }^\circ\text{C}$
Rated temperature range, short intervals	$-160 \text{ to } +150 \text{ }^\circ\text{C}$ (contact Hukseflux when measuring at $-160 \text{ }^\circ\text{C}$)
Temperature dependence	$< 0.2 \text{ } \%/^\circ\text{C}$
Non-linearity	$< 5 \text{ } \%$ ($0 \text{ to } 10 \times 10^3 \text{ W/m}^2$)
Solar absorption coefficient	0.75 (indication only)
Thermal conductivity dependence	negligible, $< 3 \text{ } \%/(\text{W/m}\cdot\text{k})$ from 270 to $0.3 \text{ W/m}\cdot\text{K}$
Sensor length and width	$(50 \times 50) \times 10^{-3} \text{ m}$
Sensing area	$9 \times 10^{-4} \text{ m}^2$
Sensing area length and width	$(30 \times 30) \times 10^{-3} \text{ m}$
Passive guard area	$16 \times 10^{-4} \text{ m}^2$
Guard width to thickness ratio	40
Sensor thickness	$0.4 \times 10^{-3} \text{ m}$
Sensor thermal resistance	$11 \times 10^{-4} \text{ K}/(\text{W/m}^2)$
Sensor thermal conductivity	$0.36 \text{ W}/(\text{m}\cdot\text{K})$
Response time (95 %)	3 s
Sensor resistance range	160 to 240Ω
Required sensor power	zero (passive sensor)

Table 3.1.1 *Specifications of FHF04 (started on previous page)*

Temperature sensor	type T thermocouple
Temperature sensor accuracy	$\pm 2\%$ (of temperature in °C), see appendix
Standard wire length	2 m
Wiring	3 x copper and 1 x constantan wire, AWG 24, stranded
Wire diameter	1×10^{-3} m
Marking	dot on foil indicating front side of the heat flux sensor; 1 x label on metal connection block, showing serial number and sensitivity
IP protection class	IP67
Rated operating relative humidity range	0 to 100 %
Use under water	FHF04 is not suitable for continuous use under water
Gross weight including 2 m wires	approx. 0.5 kg
Net weight including 2 m wires	approx. 0.5 kg
INSTALLATION AND USE	
Typical conditions of use	in experiments, in measurements in laboratory and industrial environments. Exposed to heat fluxes for periods of several minutes to several years. Connected to user-supplied data acquisition equipment. Regular inspection of the sensor. Continuous monitoring of sensor temperature. No special requirements for immunity, emission, chemical resistance.
Recommended number of sensors	2 per measurement location
Installation	see Chapter 5 on installation for recommendations
Bending	see Section 5.2 on installation on curved surfaces
Wire extension	see appendix on wire extension, or order sensors with longer wire
Sensor foil installation	see appendix on installation of FHF04 without wiring, without metal connection block
CALIBRATION	
Calibration traceability	to SI units
Product certificate	included (showing calibration result and traceability)
Calibration method	method HFPC, according to ASTM C1130 - 17
Calibration hierarchy	from SI through international standards and through an internal mathematical procedure
Calibration uncertainty	$< \pm 5\%$ ($k = 2$)
Recommended recalibration interval	2 years
Calibration reference conditions	20 °C, heat flux of 600 W/m ² , mounted on aluminium heat sink, thermal conductivity of the surrounding environment 0.0 W/(m·K)
Validity of calibration	based on experience the instrument sensitivity will not change during storage. During use the instrument "non-stability" specification is applicable. When used under conditions that differ from the calibration reference conditions, the FHF04 sensitivity to heat flux may be different than stated on its certificate. See the chapter on instrument principle for suggested solutions
Field calibration	is possible by comparison to a calibration reference sensor. Usually mounted side by side, alternative on top of the field sensor. Preferably reference and field sensor of the same model and brand. Typical duration of test > 24 h
MEASUREMENT ACCURACY	
Uncertainty of the measurement	statements about the overall measurement uncertainty can only be made on an individual basis.

Table 3.1.1 *Specifications of FHF04 (started on previous pages)*

VERSIONS / OPTIONS	
With longer wire length	option code = wire length in metres
Without wires, without metal connection block	calibrated FHF04 sensor foil to be soldered / connected by the user see appendix for more information
With black sticker applied	BLK-5050 applied to the sensor at the factory to absorb radiation
With gold sticker applied	GLD-5050 applied to the sensor at the factory to reflect radiation
ACCESSORIES	
Hand-held read-out unit	LI19 handheld read-out unit / datalogger NOTE: LI19 does not measure temperature, only heat flux
Separate black stickers	BLK-5050 to absorb radiation, to be applied by the user
Separate gold sticker	GLD-5050 to reflect radiation, to be applied by the user

3.2 Dimensions of FHF04

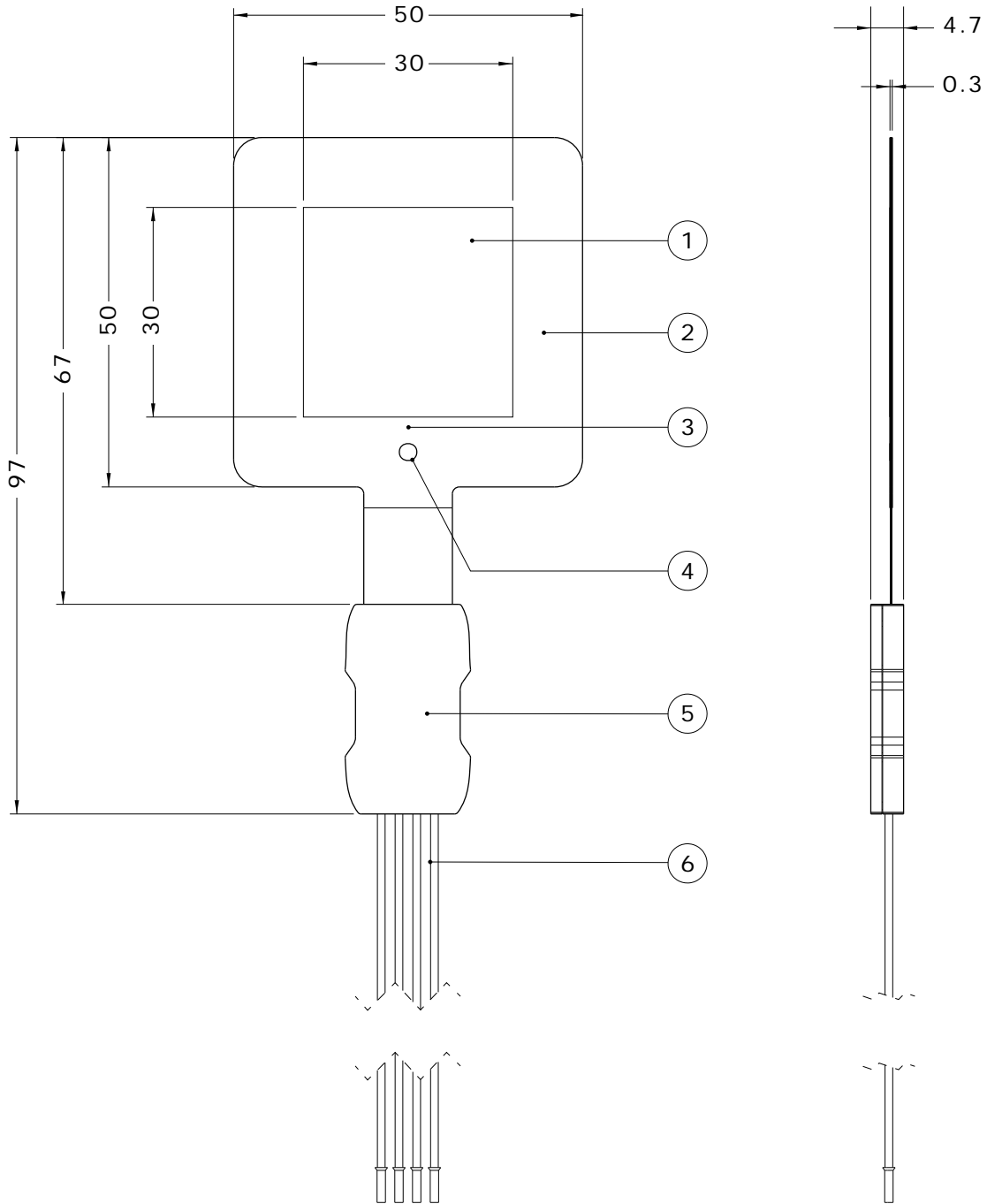

Figure 3.2.1 FHF04 heat flux sensor; dimensions in $\times 10^{-3}$ m

- (1) sensing area with thermal spreaders
- (2) passive guard
- (3) type T thermocouple
- (4) dot indicating front side
- (5) metal connection block, showing serial number and sensitivity
- (6) wires, standard length 2 m

4 Standards and recommended practices for use

FHF04 should be used in accordance with recommended practices.

4.1 Heat flux measurement in industry

FHF04 sensors are often used to measure on industrial walls and metal surfaces, estimating the installation's energy balance and the thermal transmission of walls. Typically the total measuring system consists of multiple heat flux- and temperature sensors. In many cases heat flux sensors are used for trend-monitoring. In such cases reproducibility is more important than absolute measurement accuracy.



Figure 4.1.1 Example of an FHF04 foil heat flux sensor being installed for measurement on an industrial pipe. The sensor is mounted on a well-prepared curved surface.

5 Installation of FHF04

5.1 Site selection and installation

Table 5.1.1 *Recommendations for installation of FHF04 heat flux sensors*

Location	<p>choose a location that is representative of the process that is analysed if possible, avoid exposure to sun, rain, etc.</p> <p>do not expose to drafts and lateral heat fluxes</p> <p>do not mount in the vicinity of thermal bridges, cracks, heating or cooling devices and fans</p>
Performing a representative measurement / recommended number of sensors	<p>we recommend using > 2 sensors per measurement location. This redundancy also improves the assessment of the measurement accuracy</p>
Mounting	<p>when mounting an FHF04, keep the directional sensitivity in mind</p> <p>heat flux from the back side to the front side (side with dot) generates a positive voltage output signal</p> <p>to achieve the highest accuracy temperature measurement, fix the metal connection block to the object of interest, so that the temperature of the connection block remains as close as possible to that of the heat flux sensor (see appendix)</p>
Surface cleaning and levelling	<p>create a clean and smooth surface of at least $(50 \times 50) \times 10^{-3} \text{ m}$</p>
Mechanical mounting: avoiding strain on the sensor to wire transition	<p>during installation as well as operation, the user should provide proper strain relief on the wires so that the metal connection block is not exposed to significant force</p> <p>first install the sensor by providing strain relief on the metal connection block and after that install the wires including additional strain relief</p>
Short-term installation	<p>avoid any air gaps between sensor and surface. Air thermal conductivity is in the $0.02 \text{ W}/(\text{m}\cdot\text{K})$ range, while a common glue has a thermal conductivity around $0.2 \text{ W}/(\text{m}\cdot\text{K})$. A $0.1 \times 10^{-3} \text{ m}$ air gap increases the effective thermal resistance of the sensor by 200 %</p> <p>to avoid air gaps, we recommend thermal paste or glycerol for short term installation</p> <p>use tape to fixate the sensor on the surface. If possible, tape only over the passive guard area (surrounding the sensing area). See Figure 3.2.1</p> <p>use tape to fixate the metal connection block of the sensor</p> <p>usually the wires are fixated with an additional strain relief, for example using a cable tie mount as in Figure 5.1.1</p>
Permanent installation	<p>for long-term installation fill up the space between sensor and object with silicone construction sealant, silicone glue or silicone adhesive, that can be bought at construction depots.</p> <p>we discourage the use of thermal paste for permanent installation because it tends to dry out. silicone glue is more stable and reliable</p>
Signal amplification	<p>see the paragraph on electrical connection</p>

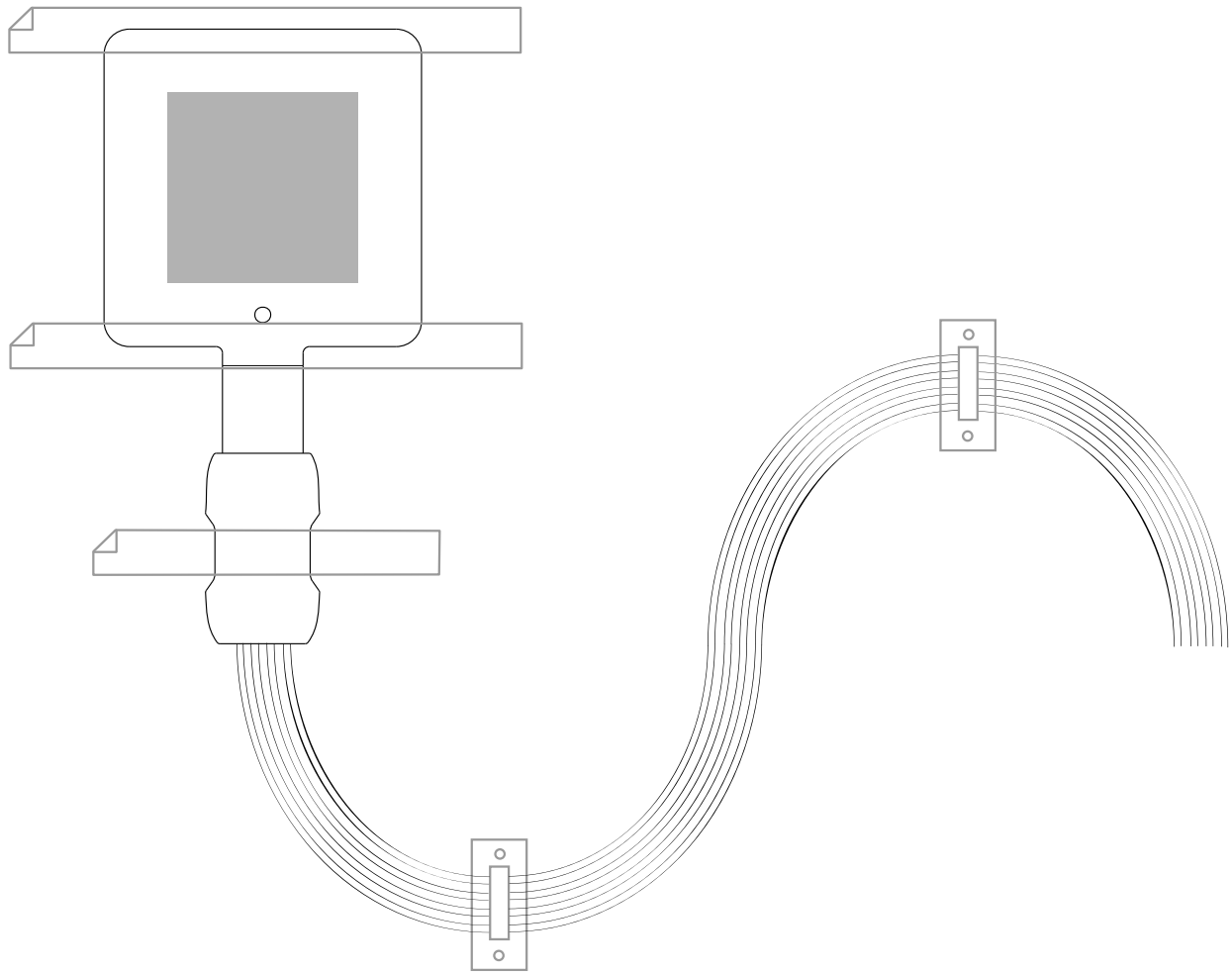

Figure 5.1.1 *Installation of FHF04 using tape to fixate the sensor and the metal connection block. Extra strain relief on the wires is provided using cable tie mounts equipped with double sided tape as adhesive. As indicated in Table 5.1.1, tapes fixating the sensor are preferably taped over the passive guard area and not on the sensing area (the latter indicated by grey shading in Figure 5.1.1). Please note the dot is visible in this image; this indicates that we are viewing the front side and that the other side, the back side, is attached on the object on which the sensor is mounted, as explained in Chapter 2.*

See also our application note on [how to install a heat flux sensor](#).

5.2 Installation on curved surfaces

The flexibility of the FHF04 makes it perfectly suitable to be installed on singly curved surfaces. The sensor can be bent around any axis.

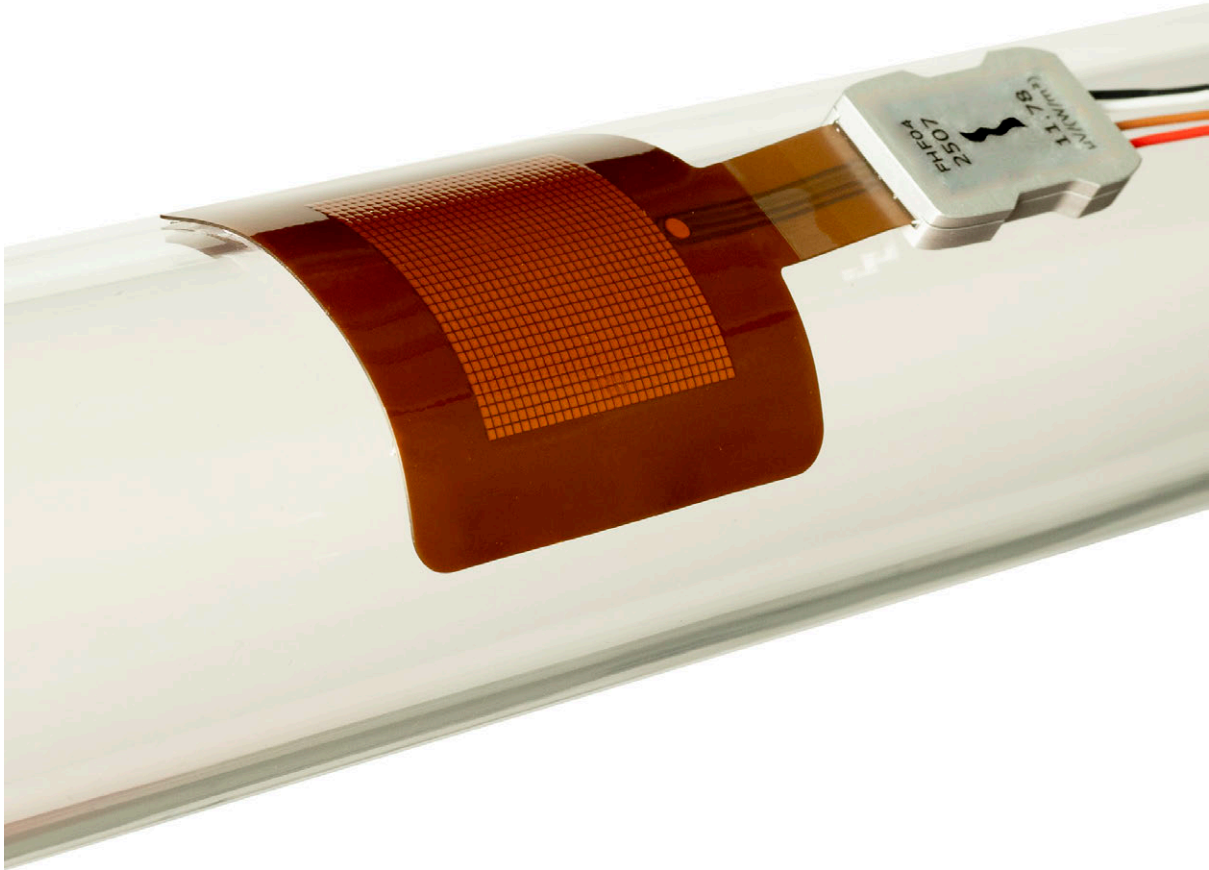

Figure 5.2.1 *Bending of an FHF04 foil heat flux sensor, in this image on a pipe.*

When measuring on curved surfaces, the same recommendations of the previous chapter apply, except that the use of thermal paste is recommended over glycerol. For installation on curved surfaces, it is usually not achievable to tape only over the passive guard area. Use sufficient tape to make sure the sensor remains fixed and in good thermal contact with curved surface. Avoid air gaps. Tape can be used over the sensing area when necessary.

Table 5.2.1 *Extra recommendations for installation of FHF04 foil heat flux sensors on curved surfaces*

Bending	Sensor can be bent in both directions
Rated bending radius	$\geq 7.5 \times 10^{-3}$ m
Effect on sensitivity	No significant influence on sensitivity

5.3 Electrical connection

5.3.1 Normal connection

A heat flux sensor should be connected to a measurement system, typically a so-called datalogger. FHF04 is a passive sensor that does not need any power. Wires may act as a source of distortion, by picking up capacitive noise. We recommend keeping the distance between a datalogger or amplifier and the sensor as short as possible and to keep the signal wires close to each other. For wire extension, see the appendix on this subject.

Table 5.3.1.1 *The electrical connection of FHF04*

WIRE	MEASUREMENT SYSTEM	
Red	heat flux signal [+]	voltage input [+]
Black	heat flux signal [-]	voltage input [-]
Brown	thermocouple type T [+]	thermocouple input [+]
White	thermocouple type T [-]	thermocouple input [-]

The sensor serial number and sensitivity are shown on the FHF04 product certificate and on FHF04's metal connection block.

NOTICE

**Putting more than 24 Volt across the sensor wiring
can lead to permanent damage to the sensor.**

5.3.2 Increasing sensitivity, connecting multiple sensors in series

Multiple sensors may be electrically connected in series. The resulting sensitivity is the sum of the sensitivity of the individual sensors. Below the equations in case two sensors are used. If needed, more than two sensors may be put in series, again increasing the sensitivity.

$$\Phi = U / (S_1 + S_2) \quad \text{(Formula 5.3.2.1)}$$

and

$$U = U_1 + U_2 \quad \text{(Formula 5.3.2.2)}$$

Table 5.3.2.1 *The electrical connection of two FHF04s, 1 and 2, in series. In such case the sensitivity is the sum of the two sensitivities of the individual sensors. More sensors may be added in a similar manner*

SENSOR	WIRE		MEASUREMENT SYSTEM
1	Red	signal 1 [+]	voltage input [+]
1	Black	signal 1 [-]	connected to signal 2 [+]
1	Brown	thermocouple type T [+]	
1	White	thermocouple type T [-]	
2	Red	signal 2 [+]	connected to signal 1 [-]
2	Black	signal 2 [-]	voltage input [-] or ground
2	Brown	thermocouple type T [+]	
2	White	thermocouple type T [-]	

The serial number and sensitivity of the individual sensors are shown on the FHF04 product certificate and FHF04's metal connection block.

5.3.3 Connection to read out half signals

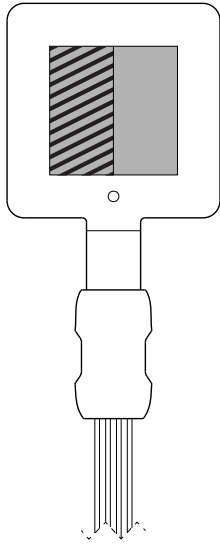

See the figure on the left: FHF04 can be connected to read out only the heat flux through the left half of the sensing area or the heat flux through the right half of the sensing area. This feature may be used for quality assurance purposes; if the sensor is correctly installed, a constant percentage of the signal will be generated by the left – and right.

Figure 5.3.3.1 FHF04 with left half indicated by diagonal lines

Table 5.3.3.1 The electrical connection of FHF04 for 100 % signal

WIRE	MEASUREMENT SYSTEM	
Red	heat flux signal [+]	voltage input [+]
Black	heat flux signal [-]	voltage input [-] or ground
Brown	thermocouple type T [+]	
White	thermocouple type T [-]	

Table 5.3.3.2 The electrical connection of FHF04 for left 50 % signal

WIRE	MEASUREMENT SYSTEM	
Red	heat flux signal [+]	voltage input [+]
Black	heat flux signal [-]	
Brown	thermocouple type T [+]	voltage input [-] or ground
White	thermocouple type T [-]	

Table 5.3.3.3 The electrical connection of FHF04 for right 50 % signal

WIRE	MEASUREMENT SYSTEM	
Red	heat flux signal [+]	
Black	heat flux signal [-]	voltage input [-] or ground
Brown	thermocouple type T [+]	voltage input [+]
White	thermocouple type T [-]	

5.4 Requirements for data acquisition / amplification

The selection and programming of dataloggers is the responsibility of the user. Please contact the supplier of the data acquisition and amplification equipment to see if directions for use with the FHF04 are available. In case a program for similar instruments is available, this can be used. FHF04 can be treated in the same way as other heat flux sensors and (analogue) thermopile pyranometers.

NOTICE

Do not use "open circuit detection" when measuring the sensor output.

Table 5.4.1 Requirements for data acquisition and amplification equipment for FHF04 in the standard configuration

Capability to measure small voltage signals	preferably: $< 5 \times 10^{-6}$ V uncertainty minimum requirement: 20×10^{-6} V uncertainty (valid for the entire expected temperature range of the acquisition / amplification equipment)
Capability for the data logger or the software	to store data, and to perform division by the sensitivity to calculate the heat flux. $\Phi = U/S$
Capability to measure thermocouple type T	preferably: $< \pm 3$ °C uncertainty
Data acquisition input resistance	$> 1 \times 10^6 \Omega$
Open circuit detection (WARNING)	open-circuit detection should not be used, unless this is done separately from the normal measurement by more than 5 times the sensor response time and with a small current only. Thermopile sensors are sensitive to the current that is used during open circuit detection. The current will generate heat, which is measured and will appear as a temporary offset.

6 Maintenance and trouble shooting

6.1 Recommended maintenance and quality assurance

FHF04 measures reliably at a low level of maintenance. Unreliable measurement results are detected by scientific judgement, for example by looking for unreasonably large or small measured values. The preferred way to obtain a reliable measurement is a regular critical review of the measured data, preferably checking against other measurements.

Table 6.1.1 *Recommended maintenance of FHF04. If possible the data analysis is done on a daily basis*

MINIMUM RECOMMENDED HEAT FLUX SENSOR MAINTENANCE			
	INTERVAL	SUBJECT	ACTION
1	1 week	data analysis	compare measured data to the maximum possible or maximum expected heat flux and to other measurements for example from redundant instruments. look for any patterns and events that deviate from what is normal or expected. compare to acceptance intervals.
2	6 months	inspection	inspect wire quality, inspect mounting, inspect location of installation
3	2 years	recalibration	recalibration by comparison to a calibration standard instrument in the field, see Paragraph 6.3. recalibration by the sensor manufacturer
4	2 years	lifetime assessment	judge if the instrument will be reliable for another 2 years, or if it should be replaced

6.2 Trouble shooting

Table 6.2.1 *Trouble shooting for FHF04*

General	<p>Inspect the sensor for any damage. Inspect the quality of mounting / installation. Inspect if the wires are properly attached to the data logger.</p> <p>Check the condition of the wires.</p> <p>Check the datalogger program, in particular if the right sensitivity is entered. FHF04 sensitivity and serial number are shown on the product certificate and on the metal connection block.</p> <p>Check the electrical resistance of the sensor between the black [-] and red [+] wires. Use a multimeter at the 1k Ω range. Measure the sensor resistance first with one polarity, then reverse the polarity. Take the average value. The typical resistance of the wiring is 0.1 Ω/m. Typical resistance should be the nominal sensor resistance of 200 Ω plus 0.2 Ω for the total resistance of two wires (back and forth) of each m. Infinite resistance indicates a broken circuit; zero or a lower than 1 Ω resistance indicates a short circuit.</p>
The sensor does not give any signal	<p>Check if the sensor reacts to heat: put the multimeter at its most sensitive range of DC voltage measurement, typically the 100 x 10⁻³ VDC range or lower. Expose the sensor to heat. Exposing the back side (the side without the dot) to heat should generate a positive signal between the red [+] and black [-] wires, doing the same at the front side (the side with dot), the sign of the output reverses.</p> <p>Check the data acquisition by replacing the sensor with a spare unit.</p>
The sensor signal is unrealistically high or low	<p>Check the wire condition.</p> <p>Check the data acquisition by applying a 1 x 10⁻⁶ V source to it in the 1 x 10⁻⁶ V range. Look at the measurement result. Check if it is as expected.</p> <p>Check the data acquisition by short circuiting the data acquisition input with a 10 Ω resistor. Look at the output. Check if the output is close to 0 W/m².</p>
The sensor signal shows unexpected variations	<p>Check the presence of strong sources of electromagnetic radiation (radar, radio).</p> <p>Check the condition of the sensor wires.</p> <p>Check if the wires are not moving during the measurement.</p>
The temperature measurement shows unrealistic values	<p>Check if the thermocouple type T is selected in the datalogger program.</p> <p>Check if a correct reference temperature is selected in the program.</p> <p>Check the electrical resistance of the thermocouple between the brown [+] and white [-] wires. Use a multimeter at the 100 Ω range. Measure the thermocouple resistance first with one polarity, then reverse the polarity. Take the average value. The typical resistance of the copper wiring is 0.1 Ω/m, for the constantan wiring this is 2.5 Ω/m. Typical resistance should be the nominal thermocouple resistance of 2.5 Ω plus 2.6 Ω for the total resistance of the two wires of each metre (back and forth). Infinite resistance indicates a broken circuit; zero or a lower than 1 Ω resistance indicates a short circuit.</p> <p>Make sure the temperature of the metal connection block remains as close as possible to that of the heat flux sensor. See appendix on temperature measurement accuracy for more information.</p>

6.3 Calibration and checks in the field

The recommended calibration interval of heat flux sensors is 2 years.
Recalibration of field heat flux sensors is ideally done by the sensor manufacturer.

On-site field calibration is possible by comparison to a calibration reference sensor.
Usually mounted side by side, alternatively mounted on top of the field sensor.

Hukseflux main recommendations for field calibrations are:

- 1) to compare to a calibration reference of the same brand and type as the field sensor
- 2) to connect both to the same electronics, so that electronics errors (also offsets) are eliminated
- 3) to mount all sensors on the same platform, so that they have the same body temperature
- 4) typical duration of test: > 24 h
- 5) typical heat fluxes used for comparison: > 200 W/m²
- 6) to correct deviations of more than $\pm 20\%$. Lower deviations should be interpreted as acceptable and should not lead to a revised sensitivity

Users may also design their own calibration experiment, for example using a well characterised foil heater.

7 Appendices

7.1 Appendix on wire extension

FHF04 is equipped with four wires. Standard wire length is 2 m. It is possible to order FHF04 with longer wire lengths or without any wires.

Wires may act as a source of distortion by picking up capacitive noise. Keep the distance between data logger or amplifier and sensor as short as possible.

In an electrically “quiet” environment the FHF04 wires may be extended without problem. If done properly, the sensor signal, although small, will not significantly degrade because the sensor resistance is very low (which results in good immunity to external sources) and because there is no current flowing (so no resistive losses).

Wire and connection specifications are summarised below.

Table 7.1.1 Preferred specifications for wire extension of FHF04

Wire	3x copper and 1 x constantan wire, AWG 24, stranded
Extension sealing	make sure any connections are sealed against humidity ingress
Conductor resistance	< 0.1 Ω /m (copper wire)
Outer diameter	typically 1×10^{-3} m
Length	wires should be kept as short as possible, in any case the total wire length should be less than 100 m
Connection	<p>either use gold plated waterproof connectors, or solder the new wire conductors and shield to those of the original sensor wire, and make a waterproof connection using heat-shrink tubing with hot-melt adhesive</p> <p>when using connectors, use dedicated type T thermocouple connectors for extending the thermocouple wires</p>

7.2 Appendix on installation of FHF04 sensor foil

FHF04 can optionally be ordered without wires and without metal connection block. The user should ensure a good connection to the sensor by either soldering wires or alternatively, using a FFC / FPC ZIF connector. See Table 7.2.1 and 7.2.2 for recommendations.

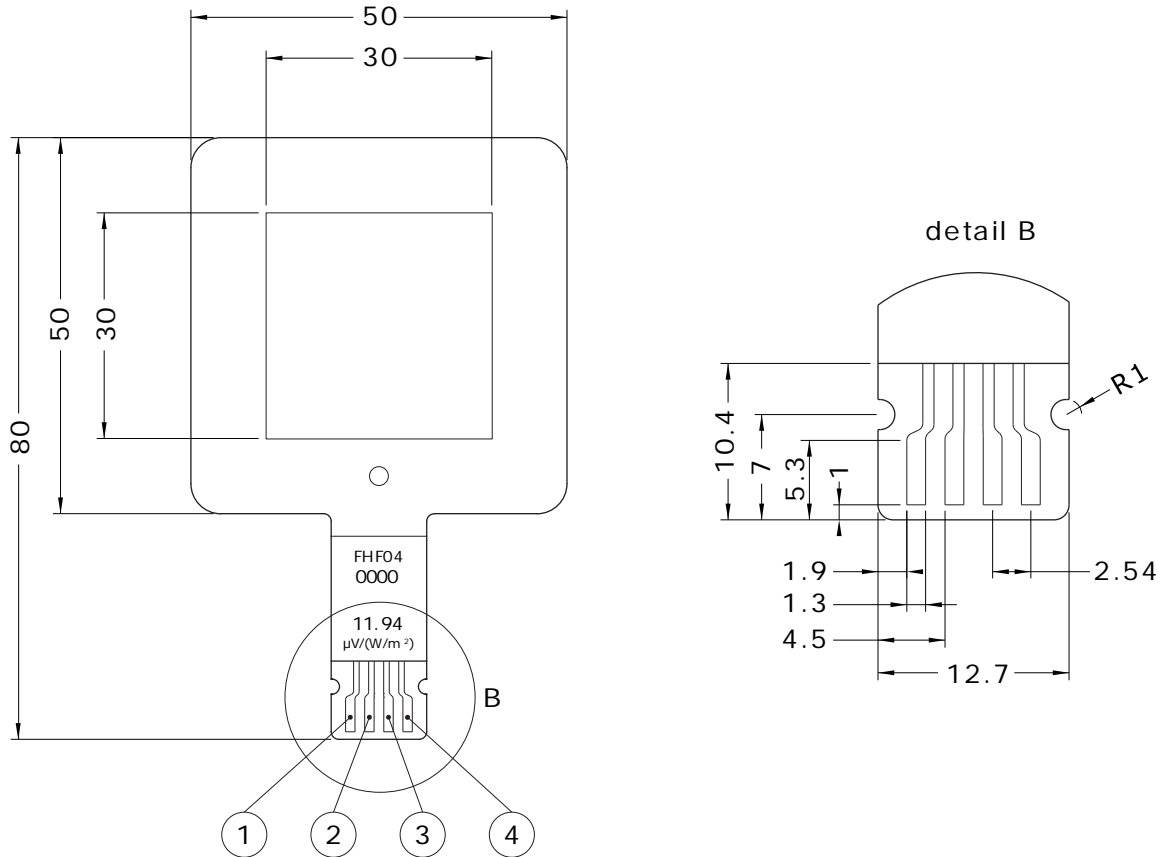

Figure 7.2.1 FHF04 sensor foil; dimensions in $\times 10^{-3}$ m

- (1) heat flux signal [+], copper
- (2) thermocouple type T [+], copper
- (3) thermocouple type T [-], constantan ($\text{Cu}_{55}\text{Ni}_{45}$)
- (4) heat flux signal [-], copper

Table 7.2.1 *recommendations for soldering of FHF04 sensor foils*

Wire	use insulated wires of preferably AWG24 see Figure 7.2.1 for which material to use on which contact
Preparation	clean soldering pad before soldering with isopropyl alcohol (IPA)
Solder material	preferably use lead free solder
Soldering temperature	use a soldering temperature of max 350 °C
Contact time	as short as possible (\pm 2 seconds)
Surface	place sensor with soldering pad on a well-insulated surface
Strain relief	add additional strain relief on the solder connections, for example by potting the connection with epoxy

NOTICE

Cross-connecting the wires while soldering will short circuit the sensor.

NOTICE

Avoid long contact while soldering as excess heat can damage the soldering contacts.



Figure 7.2.2 *FHF04 sensor foil with soldered wires.*

Table 7.2.2 *recommendations for connectors for FHF04 sensor foils*

Connector type	FFC / FPC (Flat Flex Cable / Flexible Printed Circuit)
Connector variant	ZIF (Zero Insertion Force)
Number of contacts	4 contacts
Pitch	2.54×10^{-3} m
External environment	use FHF04 sensor foils with connector in a dry and stable environment

7.3 Appendix on using FHF04 with BLK – GLD sticker series

BLK-5050 and GLD-5050 stickers are accessories to the FHF04 and FHF04SC heat flux sensors. A sensor equipped with a BLK black sticker is sensitive to both radiative and convective heat flux. A sensor equipped a GLD gold sticker reflects radiation and measures convective heat flux only. To calculate the radiative heat flux, subtract the two measurements.

BLK - GLD stickers are designed to be applied by the user. Optionally, it is also possible to order FHF04 with stickers pre-applied at the factory.

For more details, see the BLK – GLD sticker series user manual.

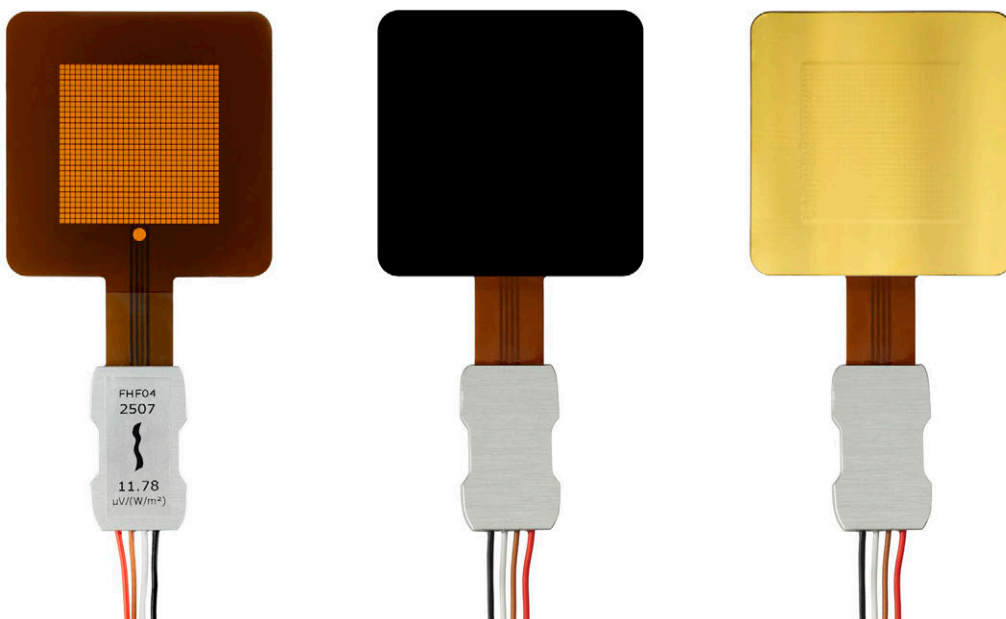

Figure 7.3.1 FHF04 heat flux sensor: with BLK-5050 and GLD-5050 stickers

Table 7.3.1 Recommendations for use of FHF04 heat flux sensors with BLK – GLD stickers

Mounting	<p>when mounting an FHF04 with a BLK or GLD sticker, keep the directional sensitivity in mind</p> <p>heat flux from the back side to the front side (side with dot) generates a positive voltage output signal.</p>
Mounting on curved surfaces	apply BLK – GLD stickers before mounting the sensor
Location	avoid direct exposure to the sun
Effect on sensitivity	no significant influence on sensitivity

7.4 Appendix on standards for calibration

The standard ASTM C1130 - 17 Standard Practice for Calibrating Thin Heat Flux Transducers specifies in chapter 6 that a guarded hot plate, a heat flowmeter, a hot box or a thin heater apparatus are all allowed. Hukseflux employs a thin heater apparatus, uses a linear function according to X1.1 and uses a nominal temperature of 20 °C, in accordance with X2.2.

The Hukseflux HFPC method relies on a thin heater apparatus according to principles as described in paragraph 4 of ASTM C1114 - 06, used in the single sided mode of operation described in paragraph 8.2 and in ASTM C1044 - 16.

ISO does not have a dedicated standard practice for heat flux sensor calibration. We follow the recommended practice of ASTM C1130 - 17.

Table 7.4.1 *heat flux sensor calibration according to ISO and ASTM*

STANDARDS ON INSTRUMENT CLASSIFICATION AND CALIBRATION	
ISO STANDARD	EQUIVALENT ASTM STANDARD
no dedicated heat flux calibration standard available.	ASTM C1130 - 17 Standard Practice for Calibrating Thin Heat Flux Transducers ASTM C 1114 - 06 Standard Test Method for Steady-State Thermal Transmission Properties by Means of the Thin-Heater Apparatus ASTM C1044 - 16 Standard Practice for Using a Guarded-Hot-Plate Apparatus or Thin-Heater Apparatus in the Single-Sided Mode

7.5 Appendix on calibration hierarchy

FHF04 factory calibration is traceable from SI through international standards and through an internal mathematical procedure that corrects for known errors. The formal traceability of the generated heat flux is through voltage and current to electrical power and electric power and through length to surface area.

The Hukseflux HFPC method follows the recommended practice of ASTM C1130 - 17. It relies on a thin heater apparatus according to principles as described in Paragraph 4 of ASTM C1114 - 06, in the single sided mode of operation described in Paragraph 8.2 and in ASTM C1044 - 16. The method has been validated in a first-party conformity assessment, by comparison to calibrations in a guarded hot plate.

7.6 Appendix on correction for temperature dependence

The sensitivity of a FHF04 depends on the temperature of the sensor. The temperature dependence of the FHF04 is specified as < 0.2 %/°C.

The calibration reference temperature is 20 °C.

Users that measure at temperatures that deviate much from 20 °C, or users that measure over a wide range of temperatures, may wish to correct for this temperature dependence.

To correct for the temperature dependence of the sensitivity, use the measurement function

$$\Phi = U/(S \cdot (1 + 0.002 \cdot (T - 20))) \quad (\text{Formula 7.6.1})$$

with Φ the heat flux in W/m², U the FHF04 voltage output in V, S the sensitivity in V/(W/m²) at 20 °C and T the FHF04 temperature.

S is shown on the product certificate and on FHF04's metal connection block .

7.7 Appendix on measurement range for different temperatures

The measurement range of FHF04 is specified as $(-10 \text{ to } +10) \times 10^3 \text{ W/m}^2$ at $20 \text{ }^\circ\text{C}$ heat sink temperature. This is a very conservative specification.

In reality, the rated temperature for continuous use of $+120 \text{ }^\circ\text{C}$ is the limiting specification. The sensor temperature T in $^\circ\text{C}$ in a specific application depends on the heatsink temperature T_{heatsink} in $^\circ\text{C}$, the heat flux Φ in W/m^2 and the thermal resistance per unit area $R_{\text{thermal,A}}$ of the sensor in $\text{K}/(\text{W/m}^2)$.

$$T = T_{\text{heatsink}} + \Phi \cdot R_{\text{thermal,A}} \quad (\text{Formula 7.7.1})$$

This means the measurement range is lower for higher heat sink temperatures.

$$\Phi_{\text{maximum}} = (120 - T_{\text{heatsink}}) / R_{\text{thermal,A}} \quad (\text{Formula 7.7.2})$$

Table 7.5.1 shows measurement ranges for different heat sink temperatures. For applications where the sensor is not mounted on a heatsink, use the ambient temperature instead of heatsink temperature.

Table 7.7.1 measurement range for different heat sink temperatures

HEATSINK TEMPERATURE	MEASUREMENT RANGE
20 $^\circ\text{C}$	$46 \times 10^3 \text{ W/m}^2$
40 $^\circ\text{C}$	$39 \times 10^3 \text{ W/m}^2$
60 $^\circ\text{C}$	$32 \times 10^3 \text{ W/m}^2$
80 $^\circ\text{C}$	$25 \times 10^3 \text{ W/m}^2$
100 $^\circ\text{C}$	$18 \times 10^3 \text{ W/m}^2$

7.8 Appendix on temperature measurement accuracy

FHF04 has an integrated thermocouple to measure temperature of the object under test. This thermocouple is supplied as a secondary measurement, in addition to the main heat flux measurement.

The FHF04 thermocouple wires are specified as a type T thermocouple, IEC 60584-1:2013 class 2. They consist of a positive copper (Cu) wire and a negative constantan (Cu₅₅Ni₄₅) wire. Accuracy is $\pm 2\%$ for temperature differences between T_2 and T_3 .

In the FHF04 sensor itself, the thermocouple junction (T_1) consists of copper and constantan traces that are extended from the metal connection block to the edge of the heat flux sensor sensitive area. These traces have slightly different Seebeck coefficients compared to the wires, which results in a higher measurement uncertainty of $\pm 5\%$ for temperature differences between T_1 and T_2 junctions.

The overall measurement uncertainty from T_1 to T_3 is the combined uncertainty of the measurements between the junctions T_1 and T_2 and between T_2 and T_3 .

In summary, we specify a $\pm 5\%$ accuracy of the absolute temperature measurement in °C. Users may achieve better results when the temperature at T_1 is kept close to the temperature T_2 .

When the temperature measurement is critical, take measures to ensure T_1 and T_2 are at the same temperature. If this is not possible, use a separate temperature sensor.

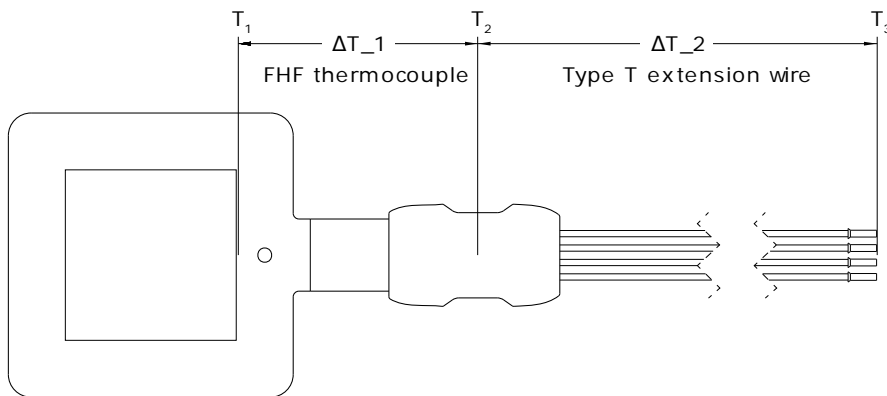

Figure 7.8.1 FHF04 thermocouple junctions

7.9 EU declaration of conformity



We, Hukseflux Thermal Sensors B.V.
Delftechpark 31
2628 XJ Delft
The Netherlands

in accordance with the requirements of the following directive:

2011/65/EU, The Restriction of Hazardous Substances Directive
(EU) 2015/863

hereby declare under our sole responsibility that:

Product model: FHF04
Product type: Foil heat flux sensor

has been designed to comply and is in conformity with the relevant sections and applicable requirements in the directive under typical conditions of use as defined in product specifications.



Eric HOEKSEMA
Director
Delft
June 29, 2021

